

Glass Blocks & Tiles, Fantasy Unlimited



LISTA DE PRECIOS | PRICE LIST: 2024_2



GAMA DE TAMAÑOS | SIZE RANGE

MM 300X300X100
(12"X12"X4")



MM 240X240X80
(9,5"X9,5"X3")



MM 190X190X100
(8"X8"X4")



MM 190X190X80
(8"X8"X3")



MM 190X190X50
(8"X8"X2")



MM 115X240X80
(4,5"X9,5"X3")



MM 150X200X100
(6"X8"X4")



MM 150X200X80
(6"X8"X3")



MM 90X190X80
(4"X8"X3")



MM 145X145X80
(6"X6"X3")



MM 115X115X80
(4,5"X4,5"X3")



GAMA DE TAMAÑOS | SIZE RANGE

MM 190X190X80
(8"X8"X3")



MM 190X190X80
(8"X8"X3")



MM 190X190X80
(8"X8"X3")



MM 105X190X80
(4"X8"X3")



MM 109/82X80
(4"/3"X3")



MM 300X300X22
(12"X12"X0,90")

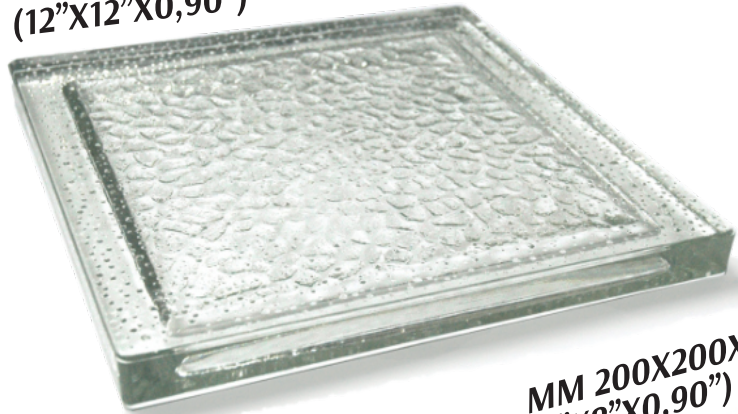

MM 190X190X100
(8"X8"X4")



MM 150X150X80
(6"X6"X3")

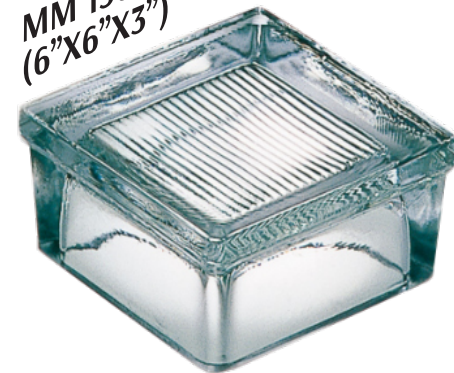

MM 200X200X22
(8"X8"X0,90")



MM 120X60
(5"X2,5")



MM 120X120X60
(5"X5"X2,5")

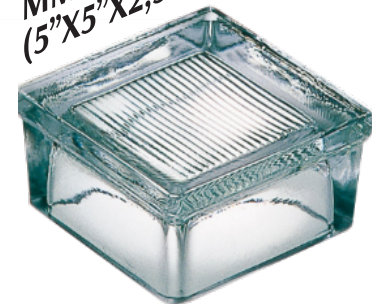

A	CUADRADO TRANSPARENTE CLEAR SQUARE	
SECCIÓN/SECTION	DESCRIPCIÓN/DESCRIPTION	PÁGINA/PAGE
A1	MM 300X300X100 TRANSPARENTE CLEAR	11
A2	MM 240X240X80 TRANSPARENTE CLEAR	11
A3	MM 190X190X95 TRANSPARENTE CLEAR	12
A4	MM 190X190X80 NUEVA TRANSPARENCIA NEW TRANSPARENCY	12
A5	MM 190X190X80 SMART TRANSPARENTE CLEAR SMART	13
A6	MM 190X190X50 TRANSPARENTE CLEAR	14
A7	MM 145X145X80 TRANSPARENTE CLEAR	14
A8	MM 115X115X80 TRANSPARENTE CLEAR	14

B	RECTANGULAR TRANSPARENTE CLEAR RECTANGULAR	
SECCIÓN/SECTION	DESCRIPCIÓN/DESCRIPTION	PÁGINA/PAGE
B1	MM 115X240X80 TRANSPARENTE CLEAR	15
B2	MM 150X200X80 SMART TRANSPARENTE CLEAR SMART	15
B3	MM 90X190X80 TRANSPARENTE CLEAR	15

C	CUADRADO COLOREADO EN MASA MASS COLORED SQUARE	
SECCIÓN/SECTION	DESCRIPCIÓN/DESCRIPTION	PÁGINA/PAGE
C1	MM 190X190X80 NEW NEVADA ONDULADO COLOREADO EN MASA MASS COLORED WAVY NEW NEVADA	16
C2	MM 190X190X80 BURBUJAS COLOREADO EN MASA MASS COLORED BUBBLE	16
C3	MM 190X190X80 ICE COLOREADO EN MASA MASS COLORED ICE	16
C4	MM 190X190X80 JAVA COLOREADO EN MASA MASS COLORED JAVA	16
C5	MM 190X190X80 SMART ONDULADO COLOREADO EN MASA MASS COLORED WAVY SMART	17

D	CUADRADO COLOREADO TECNOLOGIA REFLEJOS COLORED SQUARE REFLEJOS TECHNOLOGY	
SECCIÓN/SECTION	DESCRIPCIÓN/DESCRIPTION	PÁGINA/PAGE
D1	MM 190X190X80 REFLEJOS ONDULADO COLOREADO COLORED WAVY REFLEJOS	18

E		
CUADRADO SATINADO NEUTRO A 1 O 2 CARAS		
NEUTRAL SATIN SQUARE ON 1 OR 2 SIDES		
SECCIÓN/SECTION	DESCRIPCIÓN/DESCRIPTION	PÁGINA/PAGE
E1	MM 300X300X100 SATINADO SATIN	19
E2	MM 240X240X80 SATINADO NEUTRO NEUTRAL SATIN	19
E3	MM 190X190X80 NUEVA TRANSPARENCIA SATINADO NEW TRANSPARENCY SATIN	20
E4	MM 190X190X80 SMART SATINADO NEUTRO NEUTRAL SATIN SMART	20
E5	MM 190X190X50 SATINADO NEUTRO NEUTRAL SATIN	20
E6	MM 145X145X80 SATINADO NEUTRO NEUTRAL SATIN	21
E7	MM 115X115X80 SATINADO NEUTRO NEUTRAL SATIN	21

F		
RECTANGULAR SATINADO NEUTRO A 1 O 2 CARAS		
NEUTRAL SATIN RECTANGULAR ON 1 OR 2 SIDES		
SECCIÓN/SECTION	DESCRIPCIÓN/DESCRIPTION	PÁGINA/PAGE
F1	MM 115X240X80 SATINADO NEUTRO NEUTRAL SATIN	22
F2	MM 90X190X80 SATINADO NEUTRO NEUTRAL SATIN	22

G		
CUADRADO SATINADO COLOREADO A 2 CARAS		
COLORED SATIN SQUARE ON 2 SIDES		
SECCIÓN/SECTION	DESCRIPCIÓN/DESCRIPTION	PÁGINA/PAGE
G1	MM 190X190X80 SMART ONDULADOS SATINADOS A DOS CARAS WAVY SATIN ON 2 SIDES	23
G2	MM 190X190X80 LUX GLASS: ONDULADO SATINADO SATIN WAVY	24
G3	MM 190X190X80 LUX GLASS: LISO SATINADO SATIN SMOOTH	25

H		
TERMINAL DE PARED Y ANGULAR		
WALL AND ANGULAR TERMINAL		
SECCIÓN/SECTION	DESCRIPCIÓN/DESCRIPTION	PÁGINA/PAGE
H1	SMART GLASS BLOCK: TRANSPARENTE CLEAR	27
H2	SMART GLASS BLOCK: SATINADO SATIN	28

I		
HIGH PERFORMANCE: RESISTENCIA AL FUEGO FIRE RESISTANCE		
SECCIÓN/SECTION	DESCRIPCIÓN/DESCRIPTION	PÁGINA/PAGE
I1	HP RF 120 - 60 - 30 MINUTOS: TRANSPARENTE CLEAR	29
I2	HP RF 120 - 60 - 30 MINUTOS: SATINADO SATIN	29

J	HIGH PERFORMANCE: AISLAMIENTO TÉRMICO = UG W/m²K 0,8 THERMAL INSULATION = UG W/m²K 0,8	
SECCIÓN/SECTION	DESCRIPCIÓN/DESCRIPTION	PÁGINA/PAGE
J1	MM 190X190X135: HP AISLAMIENTO TÉRMICO TRANSPARENTE HP CLEAR THERMAL INSULATION > UG W/m ² K 0,8	30
J2	MM 190X190X135: HP AISLAMIENTO TÉRMICO SATINADO HP SATIN THERMAL INSULATION > UG W/m ² K 0,8	30

K	HIGH PERFORMANCE: AISLAMIENTO TÉRMICO = UG W/m²K 1,2 THERMAL INSULATION = UG W/m²K 1,2	
SECCIÓN/SECTION	DESCRIPCIÓN/DESCRIPTION	PÁGINA/PAGE
K1	MM 190X190X135: HP AISLAMIENTO TÉRMICO TRANSPARENTE HP CLEAR THERMAL INSULATION > UG W/M ² K 1,2	31
K2	MM 190X190X120: HP AISLAMIENTO TÉRMICO SATINADO HP SATIN THERMAL INSULATION > UG W/M ² K 1,2	31

L	HIGH PERFORMANCE: AISLAMIENTO TÉRMICO = UG W/m²K 1,0 THERMAL INSULATION = UG W/m²K 1,0	
SECCIÓN/SECTION	DESCRIPCIÓN/DESCRIPTION	PÁGINA/PAGE
L1	MM 190X190X80: HP AISLAMIENTO TÉRMICO TRANSPARENTE HP CLEAR THERMAL INSULATION > UG W/M ² K 1,0	32
L2	MM 190X190X80: HP AISLAMIENTO TÉRMICO SATINADO HP SATIN THERMAL INSULATION > UG W/M ² K 1,0	32

M	HIGH PERFORMANCE: ANTIBALAS BULLET RESISTANCE	
SECCIÓN/SECTION	DESCRIPCIÓN/DESCRIPTION	PÁGINA/PAGE
M1	MM 190X190X80: HP ANTIBALAS HP BULLET RESISTANCE	33

N	HIGH PERFORMANCE: AISLAMIENTO ACÚSTICO SOUND PROOFING	
SECCIÓN/SECTION	DESCRIPCIÓN/DESCRIPTION	PÁGINA/PAGE
N1	MM 190X190X80: HP AISLAMIENTO ACÚSTICO HP SOUND PROOFING	34

O	PERFORMANCE ROAD: PEATONALES Y SISTEMA MULTIPLO	
SECCIÓN/SECTION	DESCRIPCIÓN/DESCRIPTION	PÁGINA/PAGE
O1	PERFORMANCE ROAD: PEATONALES Y SISTEMA MULTIPLO	35
O2	ACCESORIOS PARA CONSTRUCCIÓN DE PANELES CON PERFORMANCE ROAD: SISTEMA MÚLTIPLO MULTIPLO SYSTEM	36

P	PANEL PREFABRICADO: PANELES PREFABRICADOS DE HORMIGÓN Y VIDRIO CON DESARROLLO HORIZONTAL Y VERTICAL VERTICAL USE	
SECCIÓN/SECTION	DESCRIPCIÓN/DESCRIPTION	PÁGINA/PAGE
P1	PANEL DE HORMIGÓN + BLOQUE DE VIDRIO PANEL CONCRETE + GLASS BLOCK	37

Q	PAVE DE VIDRIO PISABLE PARA EXTERIORES CON CAPTADORES FOTOVOLTAICOS SPECIAL	
SECCIÓN/SECTION	DESCRIPCIÓN/DESCRIPTION	PÁGINA/PAGE
Q1	MM 198X198X58: BLOQUE DE VIDRIO LUMINOSO PARA EXTERIORES LUMINOUS GLASS PAVING FOR OUTSIDE	38
Q2	LUPA DE CRISTAL PARA ILUMINACIÓN NATURAL GLASS LENS FOR NATURAL LIGHTING	38

R	TEJA DE VIDRIO GLASS ROOF TILE	
SECCIÓN/SECTION	DESCRIPCIÓN/DESCRIPTION	PÁGINA/PAGE
R1	TEJA DE VIDRIO TRADICIONAL TRADITIONAL GLASS ROOF TILE	39
R2	TEJA DE VIDRIO PARA CUBIERTA: OTRAS MEDIDAS Y FORMATOS GLASS TILE FOR ROOF: OTHER SIZES AND FORMATS	39

S	GLASS COVER - PERFIL DE ALUMINIO GLASS COVER - ALUMINIUM PROFILE	
SECCIÓN/SECTION	DESCRIPCIÓN/DESCRIPTION	PÁGINA/PAGE
S1	PERFIL EN ALUMINIO CURVO Y RECTANGULAR PARA EL REMATE FINAL DE PAREDES INTERIORES DE BLOQUE DE VIDRIO CURVED AND RECTANGULAR ALUMINIUM PROFILE FOR THE FINAL ROW OF WALLS INTERIORS OF GLASS BLOCK	41

T	EOLO: VENTANA DE VENTILACIÓN CON DOBLE CRISTAL Y MALLA ANTI MOSQUITOS INCORPORADA VENTILATION WINDOWS	
SECCIÓN/SECTION	DESCRIPCIÓN/DESCRIPTION	PÁGINA/PAGE
T1	VENTANA DE VENTILACIÓN CON CRISTAL Y MALLA MOSQUITERA VENTILATION WINDOWS WITH GLASS AND MOSQUITO NET	43

U	BLIZZARD: VENTANA BASCULANTE TILTING WINDOWS	
SECCIÓN/SECTION	DESCRIPCIÓN/DESCRIPTION	PÁGINA/PAGE
U1	MARCO BASCULANTE EN ACERO GALVANIZADO PARA BLOQUE DE VIDRIO TILTING FRAME IN GALVANIZED STEEL FOR GLASS BLOCK	44

V	ACCESORIOS ACCESSORIES	
SECCIÓN/SECTION	DESCRIPCIÓN/DESCRIPTION	PÁGINA/PAGE
V1	ACCESORIOS PARA LA INSTALACIÓN DE BLOQUES DE VIDRIO ACCESSORIES FOR INSTALLING GLASS BLOCKS	45

W	READYBLOCK SYSTEM	
SECCIÓN/SECTION	DESCRIPCIÓN/DESCRIPTION	PÁGINA/PAGE
W1	SISTEMA MODULAR EN ALUMINIO PARA BLOQUE DE VIDRIO. JUNTA DE 2 MM MODULAR SYSTEM IN ALUMINUM FOR GLASS BLOCK. JUNCTION OF 2 MM	46

X	READYBLOCK KIT	
SECCIÓN/SECTION	DESCRIPCIÓN/DESCRIPTION	PÁGINA/PAGE
X1	KIT READYBLOCK EN ALUMINIO. PAREDES COMPLETAS CON TODOS LOS COMPONENTES Y SILICONA BLANCA BLOQUE DE VIDRIO NO INCLUIDO READYBLOCK KIT IN ALUMINUM. COMPLETE WALLS WITH ALL THE COMPONENTS AND WHITE SILICONE GLASS BLOCK NOT INCLUDED	47

Y	METAL SYSTEM	
SECCIÓN/SECTION	DESCRIPCIÓN/DESCRIPTION	PÁGINA/PAGE
Y1	SISTEMA MODULAR EN ALUMINIO PARA PAREDES DE GRANDES Y PEQUEÑAS DIMENSIONES CON BLOQUE DE VIDRIO MODULAR ALUMINUM SYSTEM FOR LARGE AND SMALL DIMENSION WALLS WITH GLASS BLOCK	53

Z	BINARIO SYSTEM	
SECCIÓN/SECTION	DESCRIPCIÓN/DESCRIPTION	PÁGINA/PAGE
Z1	SISTEMA MODULAR EN PVC BLANCO PARA PAREDES PLANAS Y CURVAS CON BLOQUE DE VIDRIO MODULAR SYSTEM IN WHITE PVC FOR FLAT AND CURVED WALLS WITH GLASS BLOCK	54

AA	CRYSTAL FULL BRICK: LADRILLO DE VIDRIO MACIZO SOLID GLASS BRICK	
SECCIÓN/SECTION	DESCRIPCIÓN/DESCRIPTION	PÁGINA/PAGE
AA1	MM 100X200X50 - 100X100X50 NEUTRO Y SATINADO CLEAR AND SATIN	55
AA2	MM 100X200X50 COLOREADO EN MASA MASS COLOURED	55

BB	GLASS BLOCKS ALABASTER	
SECCIÓN/SECTION	DESCRIPCIÓN/DESCRIPTION	PÁGINA/PAGE
BB1	MM 190X190X90 ONDULADO-LISO WAVY-CLEAR	56







LISTA DE PRECIOS | PRICE LIST: 2024_2

EXW 12200 ONDA (CASTELLÓN) - SPAIN

A CUADRADO TRANSPARENTE | CLEAR SQUARE

A1 MM 300X300X100 TRANSPARENTE | CLEAR

	Código Code	Dimensiones Dimensions MM X MM	Descripción Description	Color Colour	Acabado Finishing	Pzas. x caja Pcs. x box Pzas. x palet Pcs. x pallet Caja x palet Box x pallet	Kgs. x pza. Kg. x pc. Kgs. x caja Kg. x box Kgs. x palet Kg. x pallet	Origen material Material origin	Plazo de entrega Delivery term	Euro pza. x palet completo Euro pc. x full pallet + IVA / TVA	Euro pza. x caja completa Euro pc. x full box + IVA / TVA
0001	BCDV/30-OTL	300x300x100	Ondulado Transparente	Transparente Clear	Ondulado Wavy	4 128 32	7,20 28,80 1010	Europa	4 semanas weeks	59,80	62,50
0002	BCDV/30-CTL	300x300x100	Neutro Liso	Transparente Clear	Liso Smooth	4 128 32	7,20 28,80 1010	Europa	4 semanas weeks	59,80	62,50
0003	BCBC/30-FVA	300x300x100	Cruzado	Transparente Clear	Cruzado Cross ribbed	4 128 32	7,20 28,80 1010	Europa	4 semanas weeks	59,80	62,50
0004	BCMB/30-WVE	300x300x100	Wave	Transparente Clear	Ondulado Wavy	4 128 32	7,00 28,00 896	Import	Bajo pedido On request	32,00	34,00
0005	BCMB/30-CWV	300x300x100	Clear View	Transparente Clear	Liso Smooth	4 128 32	7,00 28,00 896	Import	Bajo pedido On request	34,00	36,00
0006	BCMB/30-ICG	300x300x100	Iceberg	Transparente Clear	Hielo Ice	4 128 32	7,00 28,00 896	Import	Bajo pedido On request	34,00	36,00

A2 MM 240X240X80 TRANSPARENTE | CLEAR

0007	BCD/24-OT	240x240x80	Ondulado Transparente	Transparente Clear	Ondulado Wavy	4 224 56	3,80 15,20 852	Europa	Disponibile Available	13,55	14,20
0008	BCD/24-CT	240x240x80	Neutro Liso	Transparente Clear	Liso Smooth	4 224 56	3,80 15,20 852	Europa	Disponibile Available	13,55	14,20
0009	BCBC/24-FVA	240x240x80	Bastoncillo Cruzado	Transparente Clear	Bastoncillo Cross Ribbed	4 224 56	3,80 15,20 852	Europa	4 semanas weeks	20,50	21,50
0010	BCMB/24-WVE	240x240x80	Wave	Transparente Clear	Ondulado Wavy	4 392 84	3,90 15,60 1310	Import	Disponibile Available	10,00	11,00
0011	BCMB/24-CWV	240x240x80	Clear View	Transparente Clear	Liso Smooth	4 392 84	3,90 15,60 1310	Import	Disponibile Available	12,00	13,00



A CUADRADO TRANSPARENTE | CLEAR SQUARE

A3 MM 190X190X95 TRANSPARENTE | CLEAR

	Código Code	Dimensiones Dimensions MM X MM	Descripción Description	Color Colour	Acabado Finishing	Pzas. x caja Pcs. x box Pzas. x palet Pcs x pallet Caja x palet Box x pallet	Kgs. x pza. Kg. x pc. Kgs. x caja Kg. x box Kgs. x palet Kg. x pallet	Origen material Material origin	Plazo de entrega Delivery term	Euro pza. x palet completo Euro pc. x full pallet + IVA / TVA Euro pza. x caja completa Euro pc. x full box + IVA / TVA
0012	BCDV/1910-OT	190x190x95	Ondulado Transparente	Transparente Clear	Ondulado Wavy	4 336 84	2,53 15,18 907	Europa	Bajo pedido On request	9,70
0013	BCDV1910-CT	190x190x95	Neutro Liso	Transparente Clear	Liso Smooth	4 336 84	2,70 10,80 907	Europa	Bajo pedido On request	10,90
0014	BCBC/1910-FVA	190x190x95	Bastoncillo Cruzado	Transparente Clear	Bastoncillo Cross ribbed	4 336 84	2,70 10,80 907	Europa	Bajo pedido On request	9,70
0015	BCMB/1910-WVE	190x190x95	Wave	Transparente Clear	Ondulado Wavy	6 600 100	2,50 15,00 1500	Import	Bajo pedido On request	8,00
0016	BCMB/1910-CWV	190x190x95	Clear View	Transparente Clear	Liso Smooth	6 600 100	2,50 15,00 1500	Import	Bajo pedido On request	9,00
0017	BCMB/1910-QDR	190x190x95	Quadra	Transparente Clear	Bastoncillo Cross ribbed	6 600 100	2,50 15,00 1500	Import	Bajo pedido On request	9,00
0018	BCMB/1910-MST	190x190x95	Mist	Transparente Clear	Hielo Ice	6 600 100	2,50 15,00 1500	Import	Bajo pedido On request	9,00

A4 MM 190X190X80 NUEVA TRANSPARENCIA | NEW TRASPARENCY

0019	BLRF/19-NN	190x190x80	NT Nevada Ondulado Transparente	Transparente Clear	Ondulado Wavy	5 420 84	2,30 11,70 983	Europa	Disponibile Available	3,55	3,95
0020	BLRF/19-LSS	190x190x80	NT Liso Transparente	Transparente Clear	Liso Smooth	5 420 84	2,30 11,70 983	Europa	Disponibile Available	5,10	5,50
0021	BALRF/19-NR	190x190x80	NT Ice Neutro	Transparente Clear	Satinado interior Interior satin	5 420 84	2,30 11,70 983	Europa	Disponibile Available	5,10	5,50
0022	BLRF/19-ES	190x190x80	NT Ecaille	Transparente Clear	Grabados Engraved	5 420 84	2,30 11,70 983	Europa	Disponibile Available	5,45	5,98
0023	BLRF/19-JVT	190x190x80	NT Java Transparente	Transparente Clear	Grabados Engraved	5 420 84	2,30 11,70 983	Europa	Disponibile Available	4,98	5,45
0024	BLRF/19-XN	190x190x80	NT Xenon	Transparente Clear	Lineas acanaladas Ribbed lines	5 420 84	2,30 11,70 983	Europa	Disponibile Available	5,45	5,98
0025	BLRF/19-PL	190x190x80	NT Lineas Paralelas	Transparente Clear	Grabados Engraved	5 420 84	2,30 11,70 983	Europa	Disponibile Available	4,98	5,45
0026	BLRF/19-BQ	190x190x80	NT Bastoncillo	Transparente Clear	Bastoncillo cruz. Crossed ribbed	5 420 84	2,30 11,70 983	Europa	Disponibile Available	4,98	5,45
0027	BLRF/19-BBT	190x190x80	NT Bubble	Transparente Clear	Grabados Engraved	5 420 84	2,30 11,70 983	Europa	Disponibile Available	4,98	5,45
0028	BLRF/19-MS	190x190x80	NT Mosaic	Transparente Clear	Grabados Engraved	5 420 84	2,30 11,70 983	Europa	2 semanas weeks	5,45	5,98
0029	BLRF/19-PD	190x190x80	NT Pyramide	Transparente Clear	Grabados Engraved	5 420 84	2,30 11,70 983	Europa	Disponibile Available	5,45	5,98
0030	BLRF/19-WD	190x190x80	NT Wavy & Diamond	Transparente Clear	Grabados Engraved	5 420 84	2,30 11,70 983	Europa	2 semanas weeks	4,98	5,45
0031	BLRF/19-RD	190x190x80	NT Ronde	Transparente Clear	Grabados Engraved	5 420 84	2,30 11,70 983	Europa	Disponibile Available	4,98	5,45
0032	BLRF/19-ML	190x190x80	NT Marine Lens	Transparente Clear	Grabados Engraved	5 420 84	2,30 11,70 983	Europa	2 semanas weeks	4,98	5,45
0033	BLRF/19-AR	190x190x80	NT Agora	Transparente Clear	Grabados Engraved	5 420 84	2,30 11,70 983	Europa	2 semanas weeks	4,98	5,45

A CUADRADO TRANSPARENTE | CLEAR SQUARE

A5 MM 190X190X80 SMART TRANSPARENTE | CLEAR SMART

	Código Code	Dimensiones Dimensions MM X MM	Descripción Description	Color Colour	Acabado Finishing	Pzas. x caja Pcs. x box Pzas. x palet Pcs x pallet Caja x palet Box x pallet	Kgs. x pza. Kg. x pc. Kgs. x caja Kg. x box Kgs. x palet Kg. x pallet	Origen material Material origin	Plazo de entrega Delivery term	Euro pza. x palet completo Euro pc. x full pallet + IVA / TVA	Euro pza. x caja completa Euro pc. x full box + IVA / TVA
0034	BCOM/19-OTI	190x190x80	Wave	Transparente Clear	Ondulado Wavy	6 288 48	2,25 14,20 706	Import	Disponibile Available	3,70	3,95
0035	BCMB/19-CTI	190x190x80	Clear View	Transparente Clear	Liso Smooth	6 288 48	2,25 14,20 706	Import	Disponibile Available	5,10	5,50
0036	BCMB/19-QDR	190x190x80	Quadra	Transparente Clear	Grabados Engraved	6 288 48	2,25 14,20 706	Import	Disponibile Available	5,10	5,50
0037	BCMB/19-MST	190x190x80	Mist	Transparente Clear	Hielo Ice	6 288 48	2,25 14,20 706	Import	Disponibile Available	5,45	5,98
0038	BCMB/19-TBA	190x190x80	Toba	Transparente Clear	Grabados Engraved	6 288 48	2,25 14,20 706	Import	Bajo pedido On request	4,98	5,45
0039	BCMB/19-DMD	190x190x80	Diamond	Transparente Clear	Grabados Engraved	6 288 48	2,25 14,20 706	Import	Bajo pedido On request	5,45	5,98
0040	BCMB/19-CNI	190x190x80	Candi	Transparente Clear	Grabados Engraved	6 288 48	2,25 14,20 706	Import	Bajo pedido On request	5,45	5,98
0041	BCMB/19-NET	190x190x80	Net	Transparente Clear	Grabados Engraved	6 288 48	2,25 14,20 706	Import	Bajo pedido On request	4,98	5,45
0042	BCMB/19-PRA	190x190x80	Pura	Transparente Clear	Grabados Engraved	6 288 48	2,25 14,20 706	Import	Bajo pedido On request	4,98	5,45
0043	BCMB/19-BBB	190x190x80	Bubble MB	Transparente Clear	Grabados Engraved	6 288 48	2,25 14,20 706	Import	Bajo pedido On request	5,45	5,98
0044	BCMB/19-BAL	190x190x80	Bali	Transparente Clear	Grabados Engraved	6 288 48	2,25 14,20 706	Import	Bajo pedido On request	5,45	5,98
0045	BCMB/19-BMA	190x190x80	Bima	Transparente Clear	Grabados Engraved	6 288 48	2,25 14,20 706	Import	Bajo pedido On request	4,98	5,45
0046	BCMB/19-ONW	190x190x80	Ocean View	Transparente Clear	Grabados Engraved	6 288 48	2,25 14,20 706	Import	Bajo pedido On request	4,98	5,45
0047	BCMB/19-VTA	190x190x80	Vesta	Transparente Clear	Grabados Engraved	6 288 48	2,25 14,20 706	Import	Bajo pedido On request	4,98	5,45
0048	BCMB/19-TGI	190x190x80	Tangerine	Transparente Clear	Piel de mandarina Mandarin skin	6 288 48	2,25 14,20 706	Import	Bajo pedido On request	4,98	5,45
0049	BCMB/19-BOO	190x190x80	Bromo	Transparente Clear	Grabados Engraved	6 288 48	2,25 14,20 706	Import	Bajo pedido On request	5,45	5,98

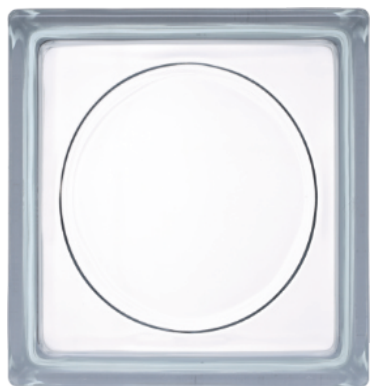

A CUADRADO TRANSPARENTE | CLEAR SQUARE

A6 MM 190X190X50 TRANSPARENTE | CLEAR

	Código Code	Dimensiones Dimensions MM X MM	Descripción Description	Color Colour	Acabado Finishing	Pzas. x caja Pcs. x box Pzas. x palet Pcs x pallet Caja x palet Box x pallet	Kgs. x pza. Kg. x pc. Kgs. x caja Kg. x box Kgs. x palet Kg. x pallet	Origen material Material origin	Plazo de entrega Delivery term	Euro pza. x palet completo Euro pc. x full pallet + IVA / TVA	Euro pza. x caja completa Euro pc. x full box + IVA / TVA
0050	BCDV/1905-OT	190x190x50	Ondulado	Transparente Clear	Ondulado Wavy	8 576 72	2,00 16,00 1152	Europa	Disponible Available	7,80	8,30
0051	BCBC/1905-FVA	190x190x50	Bastoncillo Cruzado	Transparente Clear	Bastoncillo cruz. Crossed ribbed	8 576 72	2,00 16,00 1152	Europa	2 semanas weeks	8,10	8,60
0052	BCDB/1905-BF	190x190x50	Burbujas	Transparente Clear	Burbujas Bubble	8 576 72	2,00 16,00 1152	Europa	2 semanas weeks	8,10	8,60

A7 MM 145X145X80 TRANSPARENTE | CLEAR

0053	BCMB/148-WVE	145x145x80	Wave	Transparente Clear	Ondulado Wavy	8 896 112	1,80 14,90 1612	Import	Disponible Available	6,50	7,00
0054	BCMN/148-CTI	145x145x80	Clear View	Transparente Clear	Liso Smooth	8 896 112	1,80 14,90 1612	Import	Bajo pedido On request	7,20	7,70
0055	BCMB/148-QDR	145x145x80	Quadra	Transparente Clear	Grabados Engraved	8 896 112	1,80 14,90 1612	Import	Bajo pedido On request	7,20	7,70
0056	BCMB/148-ONW	145x145x80	Ocean View	Transparente Clear	Grabados Engraved	8 896 112	1,80 14,90 1612	Import	Bajo pedido On request	7,20	7,70
0057	BCMB/148-VTA	145x145x80	Vesta	Transparente Clear	Grabados Engraved	8 896 112	1,80 14,90 1612	Import	Bajo pedido On request	7,20	7,70
0058	BCMB/148-CNI	145x145x80	Candi	Transparente Clear	Grabados Engraved	8 896 112	1,80 14,90 1612	Import	Bajo pedido On request	7,20	7,70

A8 MM 115X115X80 TRANSPARENTE | CLEAR

0059	BCDV/1108-OT	115x115x80	Ondulado Transparente	Transparente Clear	Ondulado Wavy	20 1000 50	1,20 24,00 1200	Europa	2 semanas weeks	15,00	16,75
0060	BCDV/1108-CT	115x115x80	Liso Transparente	Transparente Clear	Liso Smooth	20 1000 50	1,20 24,00 1200	Europa	2 semanas weeks	17,00	18,50
0061	BCMB/1108-WVE	115x115x80	Wave	Transparente Clear	Ondulado Wavy	16 1856 116	1,03 16,48 1911	Import	Disponible Available	7,00	8,00
0062	BCMB/1108-QDR	115x115x80	Quadra	Transparente Clear	Grabados Engraved	16 1856 116	1,03 16,48 1911	Import	Bajo pedido On request	7,00	8,00



B RECTANGULAR TRANSPARENTE | CLEAR RECTANGULAR

B1 MM 115X240X80 TRANSPARENTE | CLEAR

	Código Code	Dimensiones Dimensions MM X MM	Descripción Description	Color Colour	Acabado Finishing	Pzas. x caja Pcs. x box Pzas. x palet Pcs x pallet Caja x palet Box x pallet	Kgs. x pza. Kg. x pc. Kgs. x caja Kg. x box Kgs. x palet Kg. x pallet	Origen material Material origin	Plazo de entrega Delivery term	Euro pza. x palet completo Euro pc. x full pallet + IVA / TVA	Euro pza. x caja completa Euro pc. x full box + IVA / TVA
0063	BCDV/11-OT	115x240x80	Ondulado Transparente	Transparente Clear	Ondulado Wavy	10 500 50	2,30 23,00 1200	Europa	Bajo pedido On request	17,00	18,00
0064	BCDV/11-CTL	115x240x80	Liso Transparente	Transparente Clear	Liso Smooth	10 500 50	2,30 23,00 1911	Europa	Bajo pedido On request	18,00	18,90
0065	BCMB/11-WVE	115x240x80	Wave	Transparente Clear	Ondulado Wavy	8 288 36	2,20 17,60 634	Import	Disponibile Available	11,00	12,00
0066	BCMB/11-CTL	115x240x80	Clear View	Transparente Clear	Liso Smooth	8 288 36	2,20 17,60 634	Import	4 semanas weeks	13,00	14,00

B2 MM 150X200X80 TRANSPARENTE | CLEAR

NUEVO FORMATO | NEW FORMAT

0067	BCMB/1520-WVE	150x200x80	Wave	Transparente Clear	Ondulado Wavy	10 000 000	1,90 19,50 0000	Import	Bajo pedido On request	Consultar Consult	Consultar Consult
------	---------------	------------	------	----------------------	-----------------	----------------	---------------------	--------	--------------------------	----------------------	----------------------

B3 MM 90X190X80 TRANSPARENTE | CLEAR

0068	BCMB/09-WVE	90x190x80	Wave	Transparente Clear	Ondulado Wavy	10 1350 135	1,50 15,00 2050	Import	Disponibile Available	4,60	5,00
0069	BCMB/09-CWV	90x190x80	Clear View	Transparente Clear	Liso Smooth	10 1350 135	1,50 15,00 2050	Import	Disponibile Available	5,50	5,90
0070	BCMB/09-DMD	90x190x80	Diamond	Transparente Clear	Grabados Engraved	10 1350 135	1,50 15,00 2050	Import	Bajo pedido On request	6,00	6,50
0071	BCMB/09-TBA	90x190x80	Toba	Transparente Clear	Grabados Engraved	10 1350 135	1,50 15,00 2050	Import	Bajo pedido On request	6,00	6,50
0072	BCMB/09-CNI	90x190x80	Candi	Transparente Clear	Grabados Engraved	10 1350 135	1,50 15,00 2050	Import	Bajo pedido On request	6,00	6,50



C CUADRADO COLOREADO EN MASA | MASS COLORED SQUARE

C1 MM 190X190X80 NEW NEVADA ONDULADO COLOREADO EN MASA | MASS COLORED WAVY NEW NEVADA

	Código Code	Dimensiones Dimensions MM X MM	Descripción Description	Color Colour	Acabado Finishing	Pzas. x caja Pcs. x box Pzas. x palet Pcs x pallet Caja x palet Box x pallet	Kgs. x pza. Kg. x pc. Kgs. x caja Kg. x box Kgs. x palet Kg. x pallet	Origen material Material origin	Plazo de entrega Delivery terms	Euro pza. x palet completo Euro pc. x full pallet + IVA / TVA	Euro pza. x caja completa Euro pc. x full box + IVA / TVA
0073	BCLR/19-CB	190x190x80	New Nevada Ondulado Cobalto	Coloreado Coloured	Ondulado Wavy	5 420 84	2,30 11,70 983	Europa	2 semanas weeks	8,80	9,30
0074	BCLR/19-AL	190x190x80	New Nevada Ondulado Blue Azur	Coloreado Coloured	Ondulado Wavy	5 420 84	2,30 11,70 983	Europa	Disponible Available	7,60	8,10
0075	BCLR/19-VT	190x190x80	New Nevada Ondulado Verde	Coloreado Coloured	Ondulado Wavy	5 420 84	2,30 11,70 983	Europa	Bajo pedido On request	7,60	8,10
0076	BCLR/19-GG	190x190x80	New Nevada Ondulado Gris	Coloreado Coloured	Ondulado Wavy	5 420 84	2,30 11,70 983	Europa	Bajo pedido On request	7,60	8,10
0077	BCLR/19-BR	190x190x80	New Nevada Ondulado Bronce	Coloreado Coloured	Ondulado Wavy	5 420 84	2,30 11,70 983	Europa	Bajo pedido On request	7,60	8,10
0078	BCLR/19-TS	190x190x80	New Nevada Ondulado Turquesa	Coloreado Coloured	Ondulado Wavy	5 420 84	2,30 11,70 983	Europa	Bajo pedido On request	7,60	8,10
0079	BCLR/19-RS	190x190x80	New Nevada Ondulado Rosa	Coloreado Coloured	Ondulado Wavy	5 420 84	2,30 11,70 983	Europa	Bajo pedido On request	7,60	8,10

C2 MM 190X190X80 BURBUJAS COLOREADO EN MASA | MASS COLORED BUBBLE

0080	BBLRF/19-BA	190x190x80	Bubble Blue Azur	Coloreado Coloured	Burbujas Bubble	5 420 84	2,30 11,70 983	Europa	2 semanas weeks	8,10	8,60
0081	BBLRF/19-BR	190x190x80	Bubble Bronce	Coloreado Coloured	Burbujas Bubble	5 420 84	2,30 11,70 983	Europa	2 semanas weeks	8,10	8,60

C3 MM 190X190X80 ICE COLOREADO EN MASA | MASS COLORED ICE

0082	BALRF/19-IBA	190x190x80	Ice Satinée Transparente Blue Azur	Coloreado Coloured	Hielo Ice	5 420 84	2,30 11,70 983	Europa	2 semanas weeks	8,50	9,20
0083	BALRF/19-IRS	190x190x80	Ice Satinée Transparente Rose	Coloreado Coloured	Hielo Ice	5 420 84	2,30 11,70 983	Europa	2 semanas weeks	8,50	9,20
0084	BALRF/19-ITQ	190x190x80	Ice Satinée Transparente Turquoise	Coloreado Coloured	Hielo Ice	5 420 84	2,30 11,70 983	Europa	2 semanas weeks	8,50	9,20

C4 MM 190X190X80 JAVA COLOREADO EN MASA | MASS COLORED JAVA

0085	BJLR/19-JRE	190x190x80	Java Transparente Rose	Coloreado Coloured	Puntos Dots	5 420 84	2,30 11,70 983	Europa	2 semanas weeks	9,00	9,70
0086	BJLR/19-JBZ	190x190x80	Java Transparente Blue Azur	Coloreado Coloured	Puntos Dots	5 420 84	2,30 11,70 983	Europa	2 semanas weeks	9,00	9,70
0087	BJLR/19-TS	190x190x80	Java Transparente Turquoise	Coloreado Coloured	Puntos Dots	5 420 84	2,30 11,70 983	Europa	2 semanas weeks	9,00	9,70

C CUADRADO COLOREADO EN MASA | MASS COLORED SQUARE

C5 MM 190X190X80 SMART ONDULADO COLOREADO EN MASA | MASS COLORED WAVY SMART

	Código Code	Dimensiones Dimensions MM X MM	Descripción Description	Color Colour	Acabado Finishing	Pzas. x caja Pcs. x box Pzas. x palet Pcs x pallet Caja x palet Box x pallet	Kgs. x pza. Kg. x pc. Kgs. x caja Kg. x box Kgs. x palet Kg. x pallet	Origen material Material origin	Plazo de entrega Delivery term	Euro pza. x palet completo Euro pc. x full pallet + IVA / TVA Euro pza. x caja completa Euro pc. x full box + IVA / TVA	
0088	BCMB/198-OLHB	190x190x80	Smart Ondulado Light Blue	Coloreado Coloured	Ondulado Wavy	6 288 48	2,25 14,20 706	Import	Disponibile Available	7,00	7,50
0089	BCMB198-OGRE	190x190x80	Smart Ondulado Green	Coloreado Coloured	Ondulado Wavy	6 288 48	2,25 14,20 706	Import	Disponibile Available	7,00	7,50
0090	BCMB/198-OGEY	190x190x80	Smart Ondulado Grey	Coloreado Coloured	Ondulado Wavy	6 288 48	2,25 14,20 706	Import	Disponibile Available	7,00	7,50
0091	BCMB/198-ODKB	190x190x80	Smart Ondulado Dark Blue	Coloreado Coloured	Ondulado Wavy	6 288 48	2,25 14,20 706	Import	Disponibile Available	7,00	7,50
0092	BCMB/198-OBNE	190x190x80	Smart Ondulado Bronze	Coloreado Coloured	Ondulado Wavy	6 288 48	2,25 14,20 706	Import	Disponibile Available	7,00	7,50
0093	BCMB/198-OTRQ	190x190x80	Smart Ondulado Turquoise	Coloreado Coloured	Ondulado Wavy	6 288 48	2,25 14,20 706	Import	Disponibile Available	7,00	7,50
0094	BCMB/198-OPNK	190x190x80	Smart Ondulado Pink	Coloreado Coloured	Ondulado Wavy	6 288 48	2,25 14,20 706	Import	Marzo 2025 March	7,00	7,50

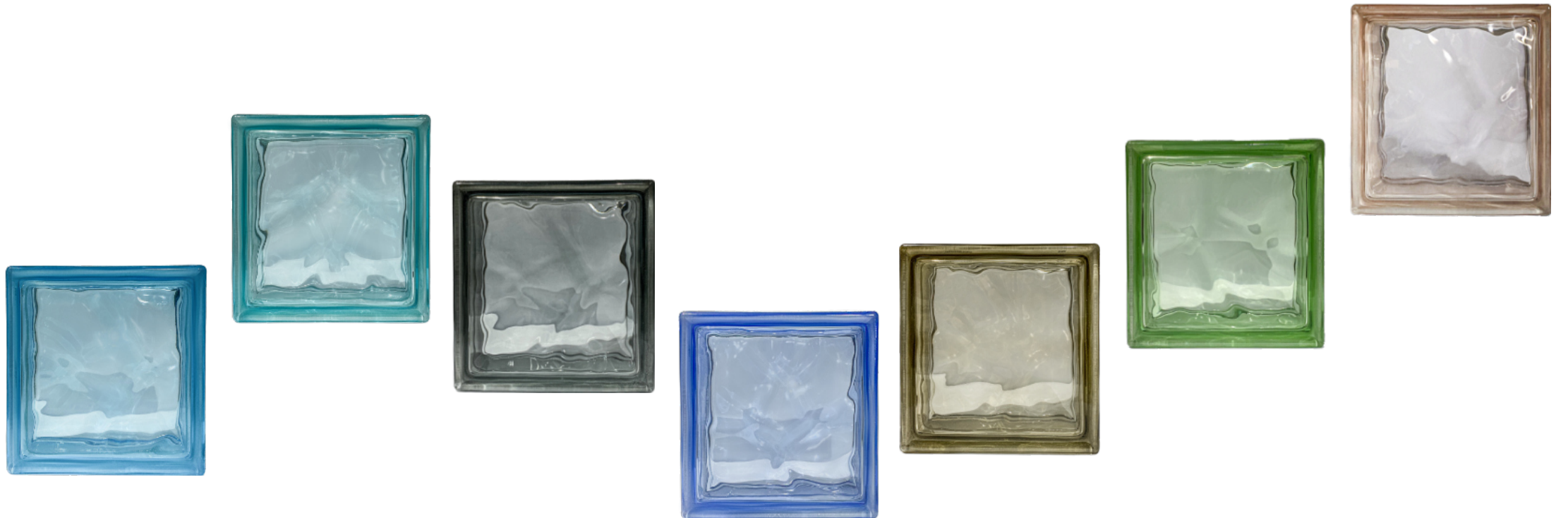

D CUADRADO COLOREADO TECNOLOGÍA REFLEJOS COLORED SQUARE REFLEJOS TECHNOLOGY

D1 MM 190X190X80 REFLEJOS ONDULADO COLOREADO | COLORED WAVY REFLEJOS

	Código Code	Dimensiones Dimensions MM X MM	Descripción Description	Color Colour	Acabado Finishing	Pzas. x caja Pcs. x box Pzas. x palet Pcs x pallet Caja x palet Box x pallet	Kgs. x pza. Kg. x pc. Kgs. x caja Kg. x box Kgs. x palet Kg. x pallet	Origen material Material origin	Plazo de entrega Delivery term	Euro pza. x palet completo Euro pc. x full pallet + IVA / TVA Euro pza. x caja completa Euro pc. x full box + IVA / TVA	
0095	BCMB/19-ANT	190x190x80	Reflejos Ondulado Antracita	Coloreado Coloured > Reflejos	Ondulado Wavy	6 288 48	2,25 14,20 706	Import	Disponibile Available	6,50	7,00
0096	BCMB/19-AZL	190x190x80	Reflejos Ondulado Indigo	Coloreado Coloured > Reflejos	Ondulado Wavy	6 288 48	2,25 14,20 706	Import	Disponibile Available	6,50	7,00
0097	BCMB/19-VER	190x190x80	Reflejos Ondulado Verde	Coloreado Coloured > Reflejos	Ondulado Wavy	6 288 48	2,25 14,20 706	Import	Disponibile Available	6,50	7,00
0098	BCMB/19-AMA	190x190x80	Reflejos Ondulado Oro	Coloreado Coloured > Reflejos	Ondulado Wavy	6 288 48	2,25 14,20 706	Import	Disponibile Available	6,50	7,00
0099	BCMB/19-ROJ	190x190x80	Refeljos Ondulado Rojo	Coloreado Coloured > Reflejos	Ondulado Wavy	6 288 48	2,25 14,20 706	Import	Disponibile Available	6,50	7,00
0100	BCMB/19-NAR	190x190x80	Reflejos Ondulado Naranja	Coloreado Coloured > Reflejos	Ondulado Wavy	6 288 48	2,25 14,20 706	Import	Disponibile Available	6,50	7,00
0101	BCMB/19-ATS	190x190x80	Reflejos Ondulado Amatista	Coloreado Coloured > Reflejos	Ondulado Wavy	6 288 48	2,25 14,20 706	Import	Disponibile Available	6,50	7,00



E CUADRADO SATINADO NEUTRO A 1 O 2 CARAS NEUTRAL SATIN SQUARE ON 1 OR 2 SIDES

E1 MM 300X300X100 SATINADO | SATIN

	Código Code	Dimensiones Dimensions MM X MM	Descripción Description	Color Colour	Acabado Finishing	Pzas. x caja Pcs. x box Pzas. x palet Pcs x pallet Caja x palet Box x pallet	Kgs. x pza. Kg. x pc. Kgs. x caja Kg. x box Kgs. x palet Kg. x pallet	Origen material Material origin	Plazo de entrega Delivery term	Euro pza. + IVA / TVA
0102	BCSV/30-CBA	300x300x100	Neutro Ondulado Satin 2C	Neutro satinado satined	Ondulado Wavy	4 128 32	7,20 28,80 1010	Made in Future Euro Trade	Bajo pedido On request	Solicitar presupuesto Ask for quote
0103	BCSV/30-CBA1	300x300x100	Neutro Ondulado Satin 1C	Neutro satinado satined	Ondulado Wavy	4 128 32	7,20 28,80 1010	Made in Future Euro Trade	Bajo pedido On request	Solicitar presupuesto Ask for quote
0104	BCLV/30-SLCA	300x300x100	Neutro Liso Satin 2C	Neutro satinado satined	Liso Smooth	4 128 32	7,20 28,80 1010	Made in Future Euro Trade	Bajo pedido On request	Solicitar presupuesto Ask for quote
0105	BCLV/30-SLCA1	300x300x100	Neutro Liso Satin 1C	Neutro satinado satined	Liso Smooth	4 128 32	7,20 28,80 1010	Made in Future Euro Trade	Bajo pedido On request	Solicitar presupuesto Ask for quote
0106	BCBC/30-IS	300x300x100	Neutro Cruzado Satin 2C	Neutro satinado satined	Cruzado Cross ribbed	4 128 32	7,20 28,80 1010	Made in Future Euro Trade	Bajo pedido On request	Solicitar presupuesto Ask for quote
0107	BCMB/30-ISA1	300x300x100	Neutro Cruzado Satin 1C	Neutro satinado satined	Cruzado Cross ribbed	4 128 32	7,20 28,80 1010	Made in Future Euro Trade	Bajo pedido On request	Solicitar presupuesto Ask for quote

E2 MM 240X240X80 SATINADO NEUTRO | NEUTRAL SATIN

	Código Code	Dimensiones Dimensions MM X MM	Descripción Description	Color Colour	Acabado Finishing	Pzas. x caja Pcs. x box Pzas. x palet Pcs x pallet Caja x palet Box x pallet	Kgs. x pza. Kg. x pc. Kgs. x caja Kg. x box Kgs. x palet Kg. x pallet	Origen material Material origin	Plazo de entrega Delivery term	Euro pza. x palet completo Euro pc. x full pallet + IVA / TVA Euro pza. x caja completa Euro pc. x full box + IVA / TVA
0108	BCS/24-CB	240x240x80	Neutro Ondulado Satin 2C	Neutro satinado satined	Ondulado Wavy	4 224 56	3,80 15,20 852	Made in Future Euro Trade	Disponibile Available	22,00 23,00
0109	BCSV/24-CBA1	240x240x80	Neutro Ondulado Satin 1C	Neutro satinado satined	Ondulado Wavy	4 224 56	3,80 15,20 852	Made in Future Euro Trade	Bajo pedido On request	22,00 23,00
0110	BCL/24-SLC	240x240x80	Neutro Liso Satin 2C	Neutro satinado satined	Liso Smooth	4 224 56	3,80 15,20 852	Made in Future Euro Trade	Disponibile Available	23,00 24,00
0111	BCLV/24-SLCA1	240x240x80	Neutro Liso Satin 1C	Neutro satinado satined	Liso Smooth	4 224 56	3,80 15,20 852	Made in Future Euro Trade	Bajo pedido On request	23,00 24,00

E CUADRADO SATINADO NEUTRO A 1 O 2 CARAS NEUTRAL SATIN SQUARE ON 1 OR 2 SIDES											
E3 MM 190X190X80 NUEVA TRANSPARENCIA SATINADO NEW TRANSPARENCY SATIN											
	Código Code	Dimensiones Dimensions MM X MM	Descripción Description	Color Colour	Acabado Finishing	Pzas. x caja Pcs. x box	Kgs. x pza. Kg. x pc.	Origen material Material origin	Plazo de entrega Delivery term	Euro pza. x palet completo Euro pc. x full pallet + IVA / TVA	Euro pza. x caja completa Euro pc. x full box + IVA / TVA
0112	BLRFV/19-NN	190x190x80	NT Nevada Neutro Ondulado Satin 2C	Neutro satinado satined	Ondulado Wavy	5 420 84	2,30 11,70 983	Made in Future Euro Trade	Disponibile Available	11,50	12,00
0113	BLRFV/19-NNA1	190x190x80	NT Nevada Neutro Ondulado Satin 1C	Neutro satinado satined	Ondulado Wavy	5 420 84	2,30 11,70 983	Made in Future Euro Trade	Bajo pedido On request	11,50	12,00
0114	BLRFV/19-LSS	190x190x80	NT Neutro Liso Satin 2C	Neutro satinado satined	Liso Smooth	5 420 84	2,30 11,70 983	Made in Future Euro Trade	Disponibile Available	12,20	12,70
0115	BLRFV/19-LSSA1	190x190x80	NT Neutro Liso Satin 1C	Neutro satinado satined	Liso Smooth	5 420 84	2,30 11,70 983	Made in Future Euro Trade	Bajo pedido On request	12,20	12,70
0116	BLRFS/19-XN	190x190x80	NT Xenos Satin 2C	Neutro satinado satined	Lineas acanaladas Ribbed lines	5 420 84	2,30 11,70 983	Made in Future Euro Trade	4 semanas weeks	16,00	16,50
0117	BLRFS/19-PL	190x190x80	NT Lineas Paralelas Satin 2C	Neutro satinado satined	Grabados Engraved	5 420 84	2,30 11,70 983	Made in Future Euro Trade	4 semanas weeks	16,00	16,50
0118	BLRFS/19-BQ	190x190x80	NT Bastoncillo Satin 2C	Neutro satinado satined	Bastoncillo cruz. Crossed ribbed	5 420 84	2,30 11,70 983	Made in Future Euro Trade	4 semanas weeks	16,00	16,50
Bajo pedido todos disponibles con acabado satinado 1C				On request all available with 1S satin							

E4 MM 190X190X80 SMART SATINADO NEUTRO NEUTRAL SATIN SMART											
0119	BCOMS/19-OTIM	190x190x80	Smart Wave Neutro Satin 2C	Neutro satinado satined	Ondulado Wavy	6 288 48	2,25 14,20 706	Import	Disponibile Available	10,00	11,00
0120	BCMBS/19-CTIM	190x190x80	Smart Clear Neutro Satin 2C	Neutro satinado satined	Liso Smooth	6 288 48	2,25 14,20 706	Import	Disponibile Available	11,00	12,00
0121	BCMBS/19-QDRM	190x190x80	Smart Quadra Neutro Satin 2C	Neutro satinado satined	Grabados Engraved	6 288 48	2,25 14,20 706	Import	Bajo pedido On request	11,50	12,00
0122	BCOMS/19-OTIM1	190x190x80	Smart Wave Neutro Satin 1C	Neutro satinado satined	Ondulado Wavy	6 288 48	2,25 14,20 706	Import	Bajo pedido On request	11,00	12,00
0123	BCMBS/19-CTIM1	190x190x80	Smart Clear Neutro Satin 1C	Neutro satinado satined	Liso Smooth	6 288 48	2,25 14,20 706	Import	Bajo pedido On request	12,00	13,00

E5 MM 190X190X50 SATINADO NEUTRO NEUTRAL SATIN											
0124	BCDVS/1905-OT	190x190x50	Ondulado Neutro Satinado 2C	Neutro satinado satined	Ondulado Wavy	8 576 72	2,00 16,00 1152	Europa	3 semanas weeks	15,80	16,50
0125	BCBCS/1905-FVA	190x190x50	Cruzado Neutro Satinado 2C	Neutro satinado satined	Bastoncillo cruz. Crossed ribbed	8 576 72	2,00 16,00 1152	Europa	3 semanas weeks	15,80	16,50
0126	BCDBS/1905-BF	190x190x50	Burbujas Neutro Satinado 2C	Neutro satinado satined	Burbujas Bubble	8 576 72	2,00 16,00 1152	Europa	3 semanas weeks	15,80	16,50
Bajo pedido todos disponibles con acabado satinado 1C				On request all available with 1S satin							

E CUADRADO SATINADO NEUTRO A 1 O 2 CARAS NEUTRAL SATIN SQUARE ON 1 OR 2 SIDES

E6 MM 145X145X80 SATINADO NEUTRO | NEUTRAL SATIN

	Código Code	Dimensiones Dimensions MM X MM	Descripción Description	Color Colour	Acabado Finishing	Pzas. x caja Pcs. x box	Kgs. x pza. Kg. x pc.	Origen material Material origin	Plazo de entrega Delivery term	Euro pza. x palet completo Euro pc. x full pallet + IVA / TVA	Euro pza. x caja completa Euro pc. x full box + IVA / TVA
0127	BCMBS/148-SWVE	145x145x80	Wave Neutro Satin 2C	Neutro satinado satined	Ondulado Wavy	10 1200 120	1,55 15,50 1890	Import	Bajo pedido On request	16,00	17,00
0128	BCMBS/148-SQDR	145x145x80	Quadra Neutro Satin 2C	Neutro satinado satined	Bastoncillo cruz. Crossed ribbed	10 1200 120	1,55 15,50 1890	Import	Bajo pedido On request	16,00	17,00
Bajo pedido todos disponibles con acabado satinado 1C				On request all available with 1S satin							

E7 MM 115X115X80 SATINADO NEUTRO | NEUTRAL SATIN

0129	BCSV/1108-CBA	115x115x80	Ondulado Neutro Satinado 2C	Neutro satinado satined	Ondulado Wavy	20 1000 50	1,20 24,00 1200	Europa	4 semanas weeks	23,50	24,80
0130	BCSV/1008-CBA1	115x115x80	Ondulado Neutro Satinado 1C	Neutro satinado satined	Ondulado Wavy	20 1000 50	1,20 24,00 1200	Europa	4 semanas weeks	23,50	24,80
0131	BCLV/1108-SLCA	115x115x80	Liso Neutro Satinado 2C	Neutro satinado satined	Liso Smooth	20 1000 50	1,20 24,00 1200	Europa	4 semanas weeks	23,50	24,80
0132	BCLV/1108-SLCA1	115x115x80	Liso Neutro Satinado 1C	Neutro satinado satined	Liso Smooth	20 1000 50	1,20 24,00 1200	Europa	4 semanas weeks	23,50	24,80
0133	BCMBS/1108-WVES	115x115x80	Wave Neutro Satin 2C	Neutro satinado satined	Ondulado Wavy	16 1856 116	1,03 16,48 1911	Import	Bajo pedido On request	18,00	19,00



F RECTANGULAR SATINADO NEUTRO A 1 O 2 CARAS NEUTRAL SATIN RECTANGULAR ON 1 OR 2 SIDES

F1 MM 115X240X80 SATINADO NEUTRO | NEUTRAL SATIN

	Código Code	Dimensiones Dimensions MM X MM	Descripción Description	Color Colour	Acabado Finishing	Pzas. x caja Pcs. x box	Kgs. x pza. Kg. x pc.	Origen material Material origin	Plazo de entrega Delivery term	Euro pza. x palet completo Euro pc. x full pallet + IVA / TVA	Euro pza. x caja completa Euro pc. x full box + IVA / TVA
0134	BCSV/11-CBA	115x240x80	Ondulado Neutro Satinado 2C	Neutro satinado satined	Ondulado Wavy	10 500 50	2,30 23,00 1200	Europa	4 semanas weeks	21,50	22,50
0135	BCLV/11-SLCA	115x240x80	Liso Neutro Satinado 2C	Neutro satinado satined	Liso Smooth	10 500 50	2,30 23,00 1200	Europa	4 semanas weeks	22,50	23,50
0136	BCMBS/11-SWE	115x240x80	Smart Wave Neutro Satin 2C	Neutro satinado satined	Ondulado Wavy	8 288 36	2,20 17,60 634	Import	Bajo pedido On request	15,00	16,00
0137	BCMBS/11-SLWV	115x240x80	Smart Clear Neutro Satin 2C	Neutro satinado satined	Liso Smooth	8 288 36	2,20 17,60 634	Import	Bajo pedido On request	16,00	17,00

F2 MM 90X190X80 SATINADO NEUTRO | NEUTRAL SATIN

0138	BCSB/09-CB	90x190x80	Ondulado Neutro Satinado 2C	Neutro satinado satined	Ondulado Wavy	6 540 90	1,30 7,80 730	Europa	3 semanas weeks	12,30	13,00
0139	BCSB/09-CBA1	90x190x80	Ondulado Neutro Satinado 1C	Neutro satinado satined	Ondulado Wavy	6 540 90	1,30 7,80 730	Europa	3 semanas weeks	13,30	14,10
0140	BCSB/09-SLCA	90x190x80	Liso Neutro Satinado 2C	Neutro satinado satined	Liso Smooth	6 540 90	1,30 7,80 730	Europa	3 semanas weeks	13,50	14,20
0141	BCSB/09-SLCA1	90x190x80	Liso Neutro Satinado 1C	Neutro satinado satined	Liso Smooth	6 540 90	1,30 7,80 730	Europa	3 semanas weeks	14,30	14,90
0142	BCMBS/09-SWE	90x190x80	Wave Neutro Satin 2C	Neutro satinado satined	Ondulado Wavy	10 1350 135	1,50 15,00 2050	Import	Disponible Available	11,00	12,00
0143	BCMBS/09-SCWV	90x190x80	Clear Neutro Satin 2C	Neutro satinado satined	Liso Smooth	10 1350 135	1,50 15,00 2050	Import	Disponible Available	11,50	12,50
Bajo pedido todos disponibles con acabado satinado 1C				On request all available with 1S satin							



G CUADRADO SATINADO COLOREADO A 2 CARAS COLORED SATIN SQUARE ON 2 SIDES

G1 MM 190X190X80 SMART ONDULADOS SATINADOS A DOS CARAS | WAVY SATIN ON 2 SIDES SMART

	Código Code	Dimensiones Dimensions MM X MM	Descripción Description	Color Colour	Acabado Finishing	Pzas. x caja Pcs. x box Pzas. x palet Pcs x pallet Caja x palet Box x pallet	Kgs. x pza. Kg. x pc. Kgs. x caja Kg. x box Kgs. x palet Kg. x pallet	Origen material Material origin	Plazo de entrega Delivery term	Euro pza. x palet completo Euro pc. x full pallet + IVA / TVA	Euro pza. x caja completa Euro pc. x full box + IVA / TVA
0144	BCMBS/19-OLHB	190x190x80	Smart Ondulado Satinado Ligh Blue 2C	Coloreado satinado Satin colored	Ondulado Wavy	6 288 48	2,25 14,20 706	Made in Future Euro Trade	4 semanas weeks	14,00	15,00
0145	BCMBS/19-OGRE	190x190x80	Smart Ondulado Satinado Green 2C	Coloreado satinado Satin colored	Ondulado Wavy	6 288 48	2,25 14,20 706	Made in Future Euro Trade	4 semanas weeks	14,00	15,00
0146	BCMBS/19-OGEY	190x190x80	Smart Ondulado Satinado Grey 2C	Coloreado satinado Satin colored	Ondulado Wavy	6 288 48	2,25 14,20 706	Made in Future Euro Trade	4 semanas weeks	14,00	15,00
0147	BCMBS/19-ODKB	190x190x80	Smart Ondulado Satinado Dark Blue 2C	Coloreado satinado Satin colored	Ondulado Wavy	6 288 48	2,25 14,20 706	Made in Future Euro Trade	4 semanas weeks	14,00	15,00
0148	BCMBS/19-OBNE	190x190x80	Smart Ondulado Satinado Bronze 2C	Coloreado satinado Satin colored	Ondulado Wavy	6 288 48	2,25 14,20 706	Made in Future Euro Trade	4 semanas weeks	14,00	15,00
0149	BCMBS/19-OTRQ	190x190x80	Smart Ondulado Satinado Turquoise 2C	Coloreado satinado Satin colored	Ondulado Wavy	6 288 48	2,25 14,20 706	Made in Future Euro Trade	4 semanas weeks	14,00	15,00
0150	BCMBS/19-OPNK	190x190x80	Smart Ondulado Satinado Pink 2C	Coloreado satinado Satin colored	Ondulado Wavy	6 288 48	2,25 14,20 706	Made in Future Euro Trade	4 semanas weeks	14,00	15,00

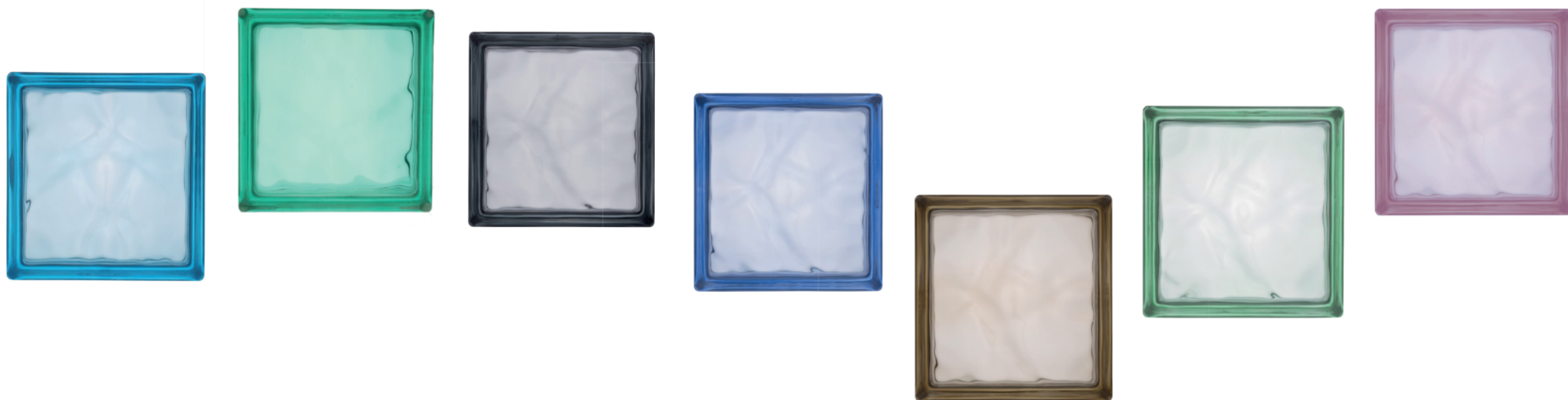

G CUADRADO SATINADO COLOREADO A 2 CARAS COLORED SATIN SQUARE ON 2 SIDES

G2 MM 190X190X80 LUX GLASS: ONDULADO SATINADO | WAVY SATIN
 PEDIDO MÍNIMO: 50 bloques de vidrio | MINIMUM ORDER: 50 glass blocks

	Código Code	Dimensiones Dimensions MM X MM	Descripción Description	Color Colour	Acabado Finishing	Pzas. x caja Pcs. x box Pzas. x palet Pcs x pallet Caja x palet Box x pallet	Kgs. x pza. Kg. x pc. Kgs. x caja Kg. x box Kgs. x palet Kg. x pallet	Origen material Material origin	Plazo de entrega Delivery term	Euro pza. por caja completa Euro pc. for full box + IVA / TVA
0151	XGS/002-GLD	190x190x80	Lux Glass Wavy Satin Gold	Coloreado satinado Satin colored	Ondulado Wavy	5 420 84	2,30 11,70 983	Made in Future Euro Trade	4 semanas weeks	21,00
0152	XGS/003-ANA	190x190x80	Lux Glass Wavy Satin Avana	Coloreado satinado Satin colored	Ondulado Wavy	5 420 84	2,30 11,70 983	Made in Future Euro Trade	4 semanas weeks	
0153	XGS/004-MKA	190x190x80	Lux Glass Wavy Satin Moka	Coloreado satinado Satin colored	Ondulado Wavy	5 420 84	2,30 11,70 983	Made in Future Euro Trade	4 semanas weeks	
0154	XGS/005-PPY	190x190x80	Lux Glass Wavy Satin Papaya	Coloreado satinado Satin colored	Ondulado Wavy	5 420 84	2,30 11,70 983	Made in Future Euro Trade	4 semanas weeks	
0155	XGS/006-RNE	190x190x80	Lux Glass Wavy Satin Orange	Coloreado satinado Satin colored	Ondulado Wavy	5 420 84	2,30 11,70 983	Made in Future Euro Trade	4 semanas weeks	
0156	XGS/007-LLW	190x190x80	Lux Glass Wavy Satin Giallo	Coloreado satinado Satin colored	Ondulado Wavy	5 420 84	2,30 11,70 983	Made in Future Euro Trade	4 semanas weeks	
0157	XGS/00008-KRN	190x190x80	Lux Glass Wavy Satin Dark Green	Coloreado satinado Satin colored	Ondulado Wavy	5 420 84	2,30 11,70 983	Made in Future Euro Trade	4 semanas weeks	
0158	XGS/009-VPU	190x190x80	Lux Glass Wavy Satin Verde Petrolio	Coloreado satinado Satin colored	Ondulado Wavy	5 420 84	2,30 11,70 983	Made in Future Euro Trade	4 semanas weeks	
0159	XGS/010-ENN	190x190x80	Lux Glass Wavy Satin Electric Green	Coloreado satinado Satin colored	Ondulado Wavy	5 420 84	2,30 11,70 983	Made in Future Euro Trade	4 semanas weeks	
0160	XGS/011-VLM	190x190x80	Lux Glass Wavy Satin Verde Lime	Coloreado satinado Satin colored	Ondulado Wavy	5 420 84	2,30 11,70 983	Made in Future Euro Trade	4 semanas weeks	
0161	XGS/012BFR	190x190x80	Lux Glass Wavy Satin Blu France	Coloreado satinado Satin colored	Ondulado Wavy	5 420 84	2,30 11,70 983	Made in Future Euro Trade	4 semanas weeks	
0162	XGS/013-RQU	190x190x80	Lux Glass Wavy Satin Turquoise	Coloreado satinado Satin colored	Ondulado Wavy	5 420 84	2,30 11,70 983	Made in Future Euro Trade	4 semanas weeks	
0163	XGS/014-ARN	190x190x80	Lux Glass Wavy Satin Acquamarina	Coloreado satinado Satin colored	Ondulado Wavy	5 420 84	2,30 11,70 983	Made in Future Euro Trade	4 semanas weeks	
0164	XGS/015-ZRO	190x190x80	Lux Glass Wavy Satin Azzurro	Coloreado satinado Satin colored	Ondulado Wavy	5 420 84	2,30 11,70 983	Made in Future Euro Trade	4 semanas weeks	
0165	XGS/016-OET	190x190x80	Lux Glass Wavy Satin Violet	Coloreado satinado Satin colored	Ondulado Wavy	5 420 84	2,30 11,70 983	Made in Future Euro Trade	4 semanas weeks	
0166	XGS/017-RFR	190x190x80	Lux Glass Wavy Satin Rosso	Coloreado satinado Satin colored	Ondulado Wavy	5 420 84	2,30 11,70 983	Made in Future Euro Trade	4 semanas weeks	
0167	XGS/018-USA	190x190x80	Lux Glass Wavy Satin Fucsia	Coloreado satinado Satin colored	Ondulado Wavy	5 420 84	2,30 11,70 983	Made in Future Euro Trade	4 semanas weeks	
0168	XGS/019-RLL	190x190x80	Lux Glass Wavy Satin Corallo	Coloreado satinado Satin colored	Ondulado Wavy	5 420 84	2,30 11,70 983	Made in Future Euro Trade	4 semanas weeks	
0169	XGS/020-LLL	190x190x80	Lux Glass Wavy Satin Lilla	Coloreado satinado Satin colored	Ondulado Wavy	5 420 84	2,30 11,70 983	Made in Future Euro Trade	4 semanas weeks	
0170	XGS/021-PRS	190x190x80	Lux Glass Wavy Satin Rosa	Coloreado satinado Satin colored	Ondulado Wavy	5 420 84	2,30 11,70 983	Made in Future Euro Trade	4 semanas weeks	
0171	XGS/022-CHC	190x190x80	Lux Glass Wavy Satin Chocolate	Coloreado satinado Satin colored	Ondulado Wavy	5 420 84	2,30 11,70 983	Made in Future Euro Trade	4 semanas weeks	
0172	XGS/023-TRT	190x190x80	Lux Glass Wavy Satin Antracite	Coloreado satinado Satin colored	Ondulado Wavy	5 420 84	2,30 11,70 983	Made in Future Euro Trade	4 semanas weeks	
0173	XGS/024-NCK	190x190x80	Lux Glass Wavy Satin Black	Coloreado satinado Satin colored	Ondulado Wavy	5 420 84	2,30 11,70 983	Made in Future Euro Trade	4 semanas weeks	

G CUADRADO SATINADO COLOREADO A 2 CARAS COLORED SATIN SQUARE ON 2 SIDES									
G2 MM 190X190X80 LUX GLASS: ONDULADO SATINADO SATIN WAVY PEDIDO MÍNIMO: 50 bloques de vidrio MINIMUM ORDER: 50 glass blocks									
Código Code	Dimensiones Dimensions MM X MM	Descripción Description	Color Colour	Acabado Finishing	Pzas. x caja Pcs. x box Pzas. x palet Pcs x pallet Caja x palet Box x pallet	Kgs. x pza. Kg. x pc. Kgs. x caja Kg. x box Kgs. x palet Kg. x pallet	Origen material Material origin	Plazo de entrega Delivery term	Euro pza. por caja completa Euro pc. for full box + IVA / TVA
0174	XGS/001-NTR	190x190x80	Lux Glass Wavy Satin Neutro	Coloreado satinado Satin colored	Ondulado Wavy	5 420 84 2,30 11,70 983	Made in Future Euro Trade	4 semanas weeks	21,00
Bajo pedido todos disponibles con acabado satinado 1C			On request all available with 1S satin						
Atención: producto artesanal con ligeras diferencias en el color y la superficie. Son peculiaridades de la producción que hacen que estos bloques de vidrio sean únicos y, por lo tanto, no pueden considerarse defectos.			Warning: handmade product with slight differences in color and surface. Are peculiarities of the production that make these glass blocks unique and therefore cannot be considered as defects.						

G3 MM 190X190X80 LUX GLASS: LISO SATINADO SATIN SMOOTH PEDIDO MÍNIMO: 50 bloques de vidrio MINIMUM ORDER: 50 glass blocks									
Código Code	Dimensiones Dimensions MM X MM	Descripción Description	Color Colour	Acabado Finishing	Pzas. x caja Pcs. x box Pzas. x palet Pcs x pallet Caja x palet Box x pallet	Kgs. x pza. Kg. x pc. Kgs. x caja Kg. x box Kgs. x palet Kg. x pallet	Origen material Material origin	Plazo de entrega Delivery term	Euro pza. por caja completa Euro pc. for full box + IVA / TVA
0175	LXGS/002-GLD	190x190x80	Lux Glass Clear View Satin Gold	Coloreado satinado Satin colored	Liso Smooth	5 420 84 2,30 11,70 983	Made in Future Euro Trade	4 semanas weeks	21,00
0176	LXGS/003-ANA	190x190x80	Lux Glass Clear View Satin Avana	Coloreado satinado Satin colored	Liso Smooth	5 420 84 2,30 11,70 983	Made in Future Euro Trade	4 semanas weeks	
0177	LXGS/004-MKA	190x190x80	Lux Glass Clear View Satin Moka	Coloreado satinado Satin colored	Liso Smooth	5 420 84 2,30 11,70 983	Made in Future Euro Trade	4 semanas weeks	
0178	LXGS/005-PPY	190x190x80	Lux Glass Clear View Satin Papaya	Coloreado satinado Satin colored	Liso Smooth	5 420 84 2,30 11,70 983	Made in Future Euro Trade	4 semanas weeks	
0179	LXGS/006-RNE	190x190x80	Lux Glass Clear View Satin Orange	Coloreado satinado Satin colored	Liso Smooth	5 420 84 2,30 11,70 983	Made in Future Euro Trade	4 semanas weeks	
0180	LXGS/007-LLW	190x190x80	Lux Glass Clear View Satin Giallo	Coloreado satinado Satin colored	Liso Smooth	5 420 84 2,30 11,70 983	Made in Future Euro Trade	4 semanas weeks	
0181	LXGS/00008-KRN	190x190x80	Lux Glass Satin Clear View Dark Green	Coloreado satinado Satin colored	Liso Smooth	5 420 84 2,30 11,70 983	Made in Future Euro Trade	4 semanas weeks	
0182	LXGS/009-VPU	190x190x80	Lux Glass Satin Clear View Verde Petrolio	Coloreado satinado Satin colored	Liso Smooth	5 420 84 2,30 11,70 983	Made in Future Euro Trade	4 semanas weeks	
0183	LXGS/010-ENN	190x190x80	Lux Glass Satin Clear View Electric Green	Coloreado satinado Satin colored	Liso Smooth	5 420 84 2,30 11,70 983	Made in Future Euro Trade	4 semanas weeks	
0184	LXGS/011-VLM	190x190x80	Lux Glass Clear View Satin Verde Lime	Coloreado satinado Satin colored	Liso Smooth	5 420 84 2,30 11,70 983	Made in Future Euro Trade	4 semanas weeks	
0185	LXGS/012BFR	190x190x80	Lux Glass Clear View Satin Blu France	Coloreado satinado Satin colored	Liso Smooth	5 420 84 2,30 11,70 983	Made in Future Euro Trade	4 semanas weeks	
0186	LXGS/013-RQU	190x190x80	Lux Glass Clear View Satin Turquoise	Coloreado satinado Satin colored	Liso Smooth	5 420 84 2,30 11,70 983	Made in Future Euro Trade	4 semanas weeks	
0187	LXGS/014-ARN	190x190x80	Lux Glass Clear View Satin Acquamarina	Coloreado satinado Satin colored	Liso Smooth	5 420 84 2,30 11,70 983	Made in Future Euro Trade	4 semanas weeks	
0188	LXGS/015-ZRO	190x190x80	Lux Glass Clear View Satin Azzurro	Coloreado satinado Satin colored	Liso Smooth	5 420 84 2,30 11,70 983	Made in Future Euro Trade	4 semanas weeks	
0189	LXGS/016-OET	190x190x80	Lux Glass Clear View Satin Violet	Coloreado satinado Satin colored	Liso Smooth	5 420 84 2,30 11,70 983	Made in Future Euro Trade	4 semanas weeks	
0190	LXGS/017-RFR	190x190x80	Lux Glass Clear View Satin Rosso	Coloreado satinado Satin colored	Liso Smooth	5 420 84 2,30 11,70 983	Made in Future Euro Trade	4 semanas weeks	

G CUADRADO SATINADO COLOREADO A 2 CARAS SQUARE SATIN COLORED ON 2 SIDES

G3 **MM 190X190X80 LUX GLASS: LISO SATINADO | SATIN SMOOTH**
PEDIDO MÍNIMO: 50 bloques de vidrio | MINIMUM ORDER: 50 glass blocks

	Código Code	Dimensiones Dimensions MM X MM	Descripción Description	Color Colour	Acabado Finishing	Pzas. x caja Pcs. x box Pzas. x palet Pcs x pallet Caja x palet Box x pallet	Kgs. x pza. Kg. x pc. Kgs. x caja Kg. x box Kgs. x palet Kg. x pallet	Origen material Material origin	Plazo de entrega Delivery term	Euro pza. por caja completa Euro pc. for full box + IVA / TVA
0191	LXGS/018-USA	190x190x80	Lux Glass Clear View Satin Fucsia	Coloreado satinado Satin colored	Liso Smooth	5 420 84	2,30 11,70 983	Made in Future Euro Trade	4 semanas weeks	21,00
0192	LXGS/019-RLL	190x190x80	Lux Glass Clear View Satin Corallo	Coloreado satinado Satin colored	Liso Smooth	5 420 84	2,30 11,70 983	Made in Future Euro Trade	4 semanas weeks	
0193	LXGS/020-LLL	190x190x80	Lux Glass Clear View Satin Lilla	Coloreado satinado Satin colored	Liso Smooth	5 420 84	2,30 11,70 983	Made in Future Euro Trade	4 semanas weeks	
0194	LXGS/021-PRS	190x190x80	Lux Glass Clear View Satin Rosa	Coloreado satinado Satin colored	Liso Smooth	5 420 84	2,30 11,70 983	Made in Future Euro Trade	4 semanas weeks	
0195	LXGS/022-CHC	190x190x80	Lux Glass Clear View Satin Chocolate	Coloreado satinado Satin colored	Liso Smooth	5 420 84	2,30 11,70 983	Made in Future Euro Trade	4 semanas weeks	
0196	LXGS/023-TRT	190x190x80	Lux Glass Clear View Satin Antracite	Coloreado satinado Satin colored	Liso Smooth	5 420 84	2,30 11,70 983	Made in Future Euro Trade	4 semanas weeks	
0197	LXGS/024-NCK	190x190x80	Lux Glass Clear View Satin Black	Coloreado satinado Satin colored	Liso Smooth	5 420 84	2,30 11,70 983	Made in Future Euro Trade	4 semanas weeks	
0198	LXGS/001-NTR	190x190x80	Lux Glass Clear View Satin Neutro	Coloreado satinado Satin colored	Liso Smooth	5 420 84	2,30 11,70 983	Made in Future Euro Trade	4 semanas weeks	
Bajo pedido todos disponibles con acabado satinado 1C			On request all available with 1S satin							
Atención: producto artesanal con ligeras diferencias en el color y la superficie. Son peculiaridades de la producción que hacen que estos bloques de vidrio sean únicos y, por lo tanto, no pueden considerarse defectos.			Warning: handmade product with slight differences in color and surface. Are peculiarities of the production that make these glass blocks unique and therefore cannot be considered as defects.							

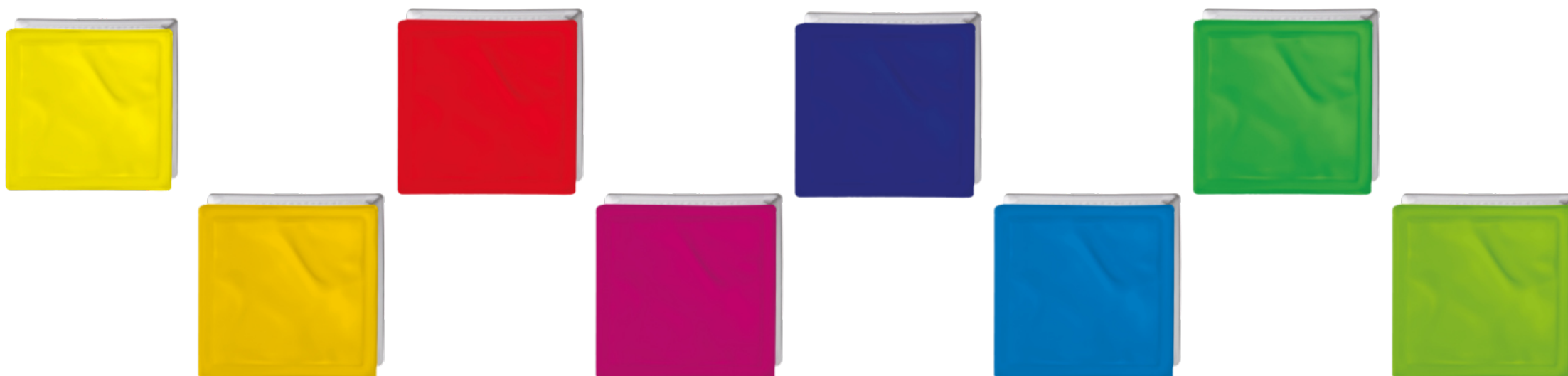

H TERMINAL DE PARED Y ANGULAR | WALL AND ANGULAR TERMINAL

H1 SMART GLASS BLOCK: TRANSPARENTE | CLEAR

	Código Code	Dimensiones Dimensions MM X MM	Descripción Description	Color Colour	Acabado Finishing	Pzas. x caja Pcs. x box	Kgs. x pza. Kg. x pc.	Origen material Material origin	Plazo de entrega Delivery term	Euro pza. por caja completa Euro pc. for full box + IVA / TVA	
						Pzas. x palet Pcs x pallet	Kgs. x caja Kg. x box				
						Caja x palet Box x pallet	Kgs. x palet Kg. x pallet				
0199	TLM/02-WVET	190x190x80	Ondulado Terminal Lineal	Transparente Clear	Ondulado Wavy	6 288 / 48	2,25 14,20 - 695	Import	Disponible Available	13,50	
0200	TLM/01-WVET	190x190x80	Ondulado Terminal Doble/ Curvo	Transparente Clear	Ondulado Wavy	6 288 / 48	2,25 14,20 - 695	Import	Disponible Available	24,00	
0201	TAM/05-WVET	105X190X80	Ondulado Corner 90°	Transparente Clear	Ondulado Wavy	8 - 288 - 36	1,60 13,15 - 485	Import	Disponible Available	21,00	
0202	TXM/03-WVET	190x190x80	Ondular Angular Redondo 3C	Transparente Clear	Ondulado Wavy	4 - 288 - 72	2,30 9,50 - 695	Import	Disponible Available	23,00	
0203	TVC/R300-WVET	R300x190x80	Ondulado para variante curva 22°	Transparente Clear	Ondulado Wavy	8 - 288 - 36	1,50 12,30 - 455	Import	Disponible Available	9,70	
0204	TLM/02-ICG	190x190x80	Iceberg Terminal Lineal	Transparente Clear	Hielo Ice	6 288 / 48	2,25 14,20 - 695	Import	Bajo pedido On request	13,50	
0205	TLM/01-ICG	190x190x80	Iceberg Terminal Doble/ Curvo	Transparente Clear	Hielo Ice	6 288 / 48	2,25 14,20 - 695	Import	Bajo pedido On request	24,00	
0206	TLM/02-CWV	190x190x80	Liso Terminal Lineal	Transparente Clear	Liso Smooth	6 288 / 48	2,25 14,20 - 695	Import	Disponible Available	15,50	
0207	TLM/01-CWV	190x190x80	Liso Terminal Doble/ Curvo	Transparente Clear	Liso Smooth	6 288 / 48	2,25 14,20 - 695	Import	Disponible Available	26,00	
0208	TAM/05-CWV	105x190x80	Liso Corner 90°	Transparente Clear	Liso Smooth	8 - 288 - 36	1,60 13,15 - 485	Import	Disponible Available	23,00	
0209	TXM/03-CWV	190x190x80	Liso Angular Redondo 3C	Transparente Clear	Liso Smooth	4 - 288 - 72	2,30 9,50 - 695	Import	Bajo pedido On request	25,00	
0210	TVC/R300-CWV	R300x190x80	Liso para variante curva 22°	Transparente Clear	Liso Smooth	8 - 288 - 36	1,50 12,30 - 455	Import	Bajo pedido On request	9,70	
Bajo pedido disponible en formato 190x190x95 mm				On request available in the 190x190x95 mm format							



H TERMINAL DE PARED Y ANGULAR | WALL AND ANGULAR TERMINAL

H2 SMART GLASS BLOCK: SATINADO | SATIN

	Código Code	Dimensiones Dimensions MM X MM	Descripción Description	Color Colour	Acabado Finishing	Pzas. x caja Pcs. x box	Kgs. x pza. Kg. x pc.	Origen material Material origin	Plazo de entrega Delivery term	Euro pza. por caja completa Euro pc. for full box + IVA / TVA
						Pzas. x palet Pcs x pallet	Kgs. x caja Kg. x box			
						Caja x palet Box x pallet	Kgs. x palet Kg. x pallet			
0211	TLSM/02-WVET	190x190x80	Wave Terminal Lineal	Neutro satinado satined	Ondulado Wavy	6 288 / 48	2,25 14,20 - 695	Import	Disponible Available	28,00
0212	TLSM/01-WVET	190x190x80	Wave Terminal Doble/ Curvo	Neutro satinado satined	Ondulado Wavy	6 288 / 48	2,25 14,20 - 695	Import	Disponible Available	42,00
0213	TASM/05-WVET	105x190x80	Wave Corner 90°	Neutro satinado satined	Ondulado Wavy	8 - 288 - 36	1,60 13,15 - 485	Import	Disponible Available	42,00
0214	TXSM/03-WVET	190x190x80	Wave Angular Redondo 3C	Neutro satinado satined	Ondulado Wavy	4 - 288 - 72	2,30 9,50 - 695	Import	Disponible Available	45,00
0215	TVSC/R300-WVET	R300x190x80	Wave para variante curva 22°	Neutro satinado satined	Ondulado Wavy	8 - 288 - 36	1,50 12,30 - 455	Import	Disponible Available	16,50
0216	TLSM/02-CWV	190x190x80	Clear Terminal Lineal	Neutro satinado satined	Liso Smooth	6 288 / 48	2,25 14,20 - 695	Import	Bajo pedido On request	28,00
0217	TLSM/01-CWV	190x190x80	Clear Terminal Doble/ Curvo	Neutro satinado satined	Liso Smooth	6 288 / 48	2,25 14,20 - 695	Import	Bajo pedido On request	42,00
0218	TASM/05-CWV	105x190x80	Clear Corner 90°	Neutro satinado satined	Liso Smooth	8 - 288 - 36	1,60 13,15 - 485	Import	Bajo pedido On request	42,00
0219	TXSM/03-CWV	190x190x80	Clear Angular Redondo 3C	Neutro satinado satined	Liso Smooth	4 - 288 - 72	2,30 9,50 - 695	Import	Bajo pedido On request	45,00
0220	TVSC/R300-CWV	R300x190x80	Clear para variante curva 22°	Neutro satinado satined	Liso Smooth	8 - 288 - 36	1,50 12,30 - 455	Import	Bajo pedido On request	16,50
Bajo pedido disponible en formato 190x190x95 mm				On request available in the 190x190x95 mm format						

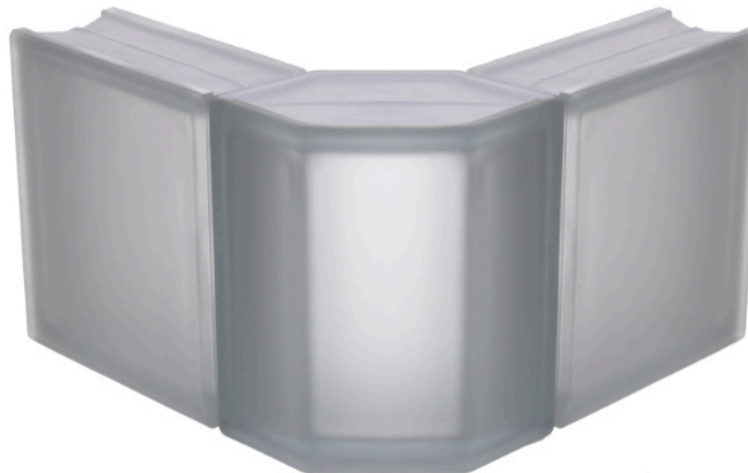

I HIGH PERFORMANCE: RESISTENCIA AL FUEGO | FIRE RESISTANCE

Recomendación de almacenamiento: conservar en un lugar ventilado, fresco y seco. | Storage recommendation: store in a ventilated, cool and dry place.

II HP RF 120 - 60 - 30 MINUTOS: TRANSPARENTE | CLEAR

	Código Code	Dimensiones Dimensions MM X MM	Descripción Description	Color Colour	Acabado Finishing	Pzas. x caja Pcs. x box	Kgs. x pza. Kg. x pc.	Origen material Material origin	Plazo de entrega Delivery term	Euro pza. por caja completa Euro pc. for full box + IVA / TVA
0221	HP/RF-120	190x190x200	HP RF 120 Liso Transparente	Transparente Clear	Liso transparente Clear smooth	2 168 84	7,32 15,00 1260	Europa	6/8 semanas weeks	105,00
0222	HP/RFL60-0	190x190x150	HP RF 60 Ondulado Transparente	Transparente Clear	Ondulado Wavy	2 168 84	6,50 13,30 1117	Europa	6/8 semanas weeks	80,00
0223	HP/RFL-60	190x190x150	HP RF 60 Liso Transparente	Transparente Clear	Liso transparente Clear smooth	2 168 84	6,50 13,30 1117	Europa	6/8 semanas weeks	80,00
0224	HPTK/RFO-60	190x190x80	HP RF 60 Thick Fire Wave	Transparente Clear	Ondulado Wavy	4 288 72	4,00 16,00 1152	Import	Bajo pedido On request	50,00
0225	HP/RFL30-0	190x190x100	HP RF 30 Ondulado Transparente	Transparente Clear	Ondulado Wavy	4 288 72	4,00 16,00 1152	Europa	6/8 semanas weeks	48,00
0226	HP/RFL-30	190x190x100	HP RF 30 Liso Transparente	Transparente Clear	Liso transparente Clear smooth	4 288 72	4,00 16,00 1152	Europa	6/8 semanas weeks	48,00

II HP RF 120 - 60 - 30 MINUTOS: SATINADO | SATIN

0227	HP/RFLS2-120	190x190x200	HP RF 120 Liso Neutro Satinado 2C	Neutro satinado satinado	Liso Smooth	2 168 84	7,32 15,00 1260	Europa	7/8 semanas weeks	121,00
0228	HP/RFLS1-120	190x190x200	HP RF 120 Liso Neutro Satinado 1C	Neutro satinado satinado	Liso Smooth	2 168 84	7,32 15,00 1260	Europa	7/8 semanas weeks	121,00
0229	HP/RFL60-2SO	190x190x150	HP RF 60 Ondulado Neutro Satinado 2C	Neutro satinado satinado	Ondulado Wavy	2 168 84	6,50 13,30 1117	Europa	7/8 semanas weeks	90,00
0230	HP/RFL60-1SO	190x190x150	HP RF 60 Ondulado Neutro Satinado 1C	Neutro satinado satinado	Ondulado Wavy	2 168 84	6,50 13,30 1117	Europa	7/8 semanas weeks	90,00
0231	HP/RFLS2-60	190x190x150	HP RF 60 Liso Neutro Satinado 2C	Neutro satinado satinado	Liso Smooth	2 168 84	6,50 13,30 1117	Europa	7/8 semanas weeks	90,00
0232	HP/RFLS1-60	190x190x150	HP RF 60 Liso Neutro Satinado 1C	Neutro satinado satinado	Liso Smooth	2 168 84	6,50 13,30 1117	Europa	7/8 semanas weeks	90,00
0233	HPTKS/RFO-2S60	190x190x80	HP RF 60 Thick Fire Wave Satin 2C	Neutro satinado satinado	Ondulado Wavy	4 288 72	4,00 16,00 1152	Import	Bajo pedido On request	60,00
0234	HPTKS/RFO-1S60	190x190x80	HP RF 60 Thick Fire Wave Satin 1C	Neutro satinado satinado	Ondulado Wavy	4 288 72	4,00 16,00 1152	Import	Bajo pedido On request	60,00
0235	HP/RFL30-2SO	190x190x100	HP RF 30 Ondulado Neutro Satinado 2C	Neutro satinado satinado	Ondulado Wavy	4 288 72	4,00 16,00 1152	Europa	7/8 semanas weeks	61,00
0236	HP/RFL30-1SO	190x190x100	HP RF 30 Ondulado Neutro Satinado 1C	Neutro satinado satinado	Ondulado Wavy	4 288 72	4,00 16,00 1152	Europa	7/8 semanas weeks	61,00
0237	HP/RFLS2-30	190x190x100	HP RF 30 Liso Neutro Satinado 2C	Neutro satinado satinado	Liso Smooth	4 288 72	4,00 16,00 1152	Europa	7/8 semanas weeks	61,00
0238	HP/RFLS1-30	190x190x100	HP RF 30 Liso Neutro Satinado 1C	Neutro satinado satinado	Liso Smooth	4 288 72	4,00 16,00 1152	Europa	7/8 semanas weeks	61,00

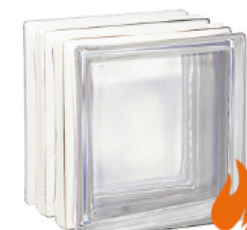

J HIGH PERFORMANCE: AISLAMIENTO TÉRMICO PLUS = Ug W/m²K 0,8 THERMAL INSULATION PLUS = Ug W/m²K 0,8

Recomendación de almacenamiento: conservar en un lugar ventilado, fresco y seco. | Storage recommendation: store in a ventilated, cool and dry place.

J1 MM 190X190X135: HP AISLAMIENTO TÉRMICO TRANSPARENTE PLUS | HP CLEAR THERMAL INSULATION PLUS > Ug W/m²K 0,8

	Código Code	Dimensiones Dimensions MM X MM	Descripción Description	Color Colour	Acabado Finishing	Pzas. x caja Pcs. x box	Kgs. x pza. Kg. x pc.	Origen material Material origin	Plazo de entrega Delivery term	Euro pza. por caja completa Euro pc. for full box + IVA / TVA
0239	HP/ATIS-080	190x190x135	HP Thermal Insulation IS	Transparente Clear	Cruzado Cross ribbed	3 156 52	5,40 16,40 883	Europa	3/5 semanas weeks	59,00
0240	HB/ATBB-080	190x190x135	HP Thermal Insulation Bubble	Transparente Clear	Grabados Engraved	3 156 52	5,40 16,40 883	Europa	3/5 semanas weeks	59,00
0240A	HP/ATNR-080	190x190x135	HP Thermal Insulation Ice	Transparente Clear	Satinado interior Interior satin	3 156 52	5,40 16,40 883	Europa	3/5 semanas weeks	59,00
0240B	HP/ATRD-080	190x190x135	HP Thermal Insulation Ronde	Transparente Clear	Grabados Engraved	3 156 52	5,40 16,40 883	Europa	3/5 semanas weeks	59,00
0241	HP/ATWV-080	190x190x135	HP Thermal Insulation Wave	Transparente Clear	Ondulado Wavy	3 156 52	5,40 16,40 883	Europa	3/5 semanas weeks	57,00
0242	HP/ATCW-080	190x190x135	HP Thermal Insulation Clear View	Transparente Clear	Liso transparente Clear smooth	3 156 52	5,40 16,40 883	Europa	3/5 semanas weeks	59,00

J2 MM 190X190X135: HP AISLAMIENTO TÉRMICO SATINADO PLUS | HP SATIN THERMAL INSULATION PLUS > UG W/M²K 0,8

0243	HP/ATIS-080S2	190x190x135	HP Thermal Insulation IS Satin 2L	Neutro satinado satined	Cruzado Cross ribbed	3 156 52	5,40 16,40 883	Europa	4/6 semanas weeks	69,00
0244	HP/ATIS-080S1	190x190x135	HP Thermal Insulation IS Satin 1L	Neutro satinado satined	Cruzado Cross ribbed	3 156 52	5,40 16,40 883	Europa	4/6 semanas weeks	67,00
0245	HP/ATBB-080S2	190x190x135	HP Thermal Insulation Bubble Satin 2L	Neutro satinado satined	Grabados Engraved	3 156 52	5,40 16,40 883	Europa	4/6 semanas weeks	69,00
0246	HP/ATRD-080S2	190x190x135	HP Thermal Insulation Ronde Satin 2L	Neutro satinado satined	Grabados Engraved	3 156 52	5,40 16,40 883	Europa	4/6 semanas weeks	69,00
0247	HP/ATWV-080S2	190x190x135	HP Thermal Insulation Wave Satin 2L	Neutro satinado satined	Ondulado Wavy	3 156 52	5,40 16,40 883	Europa	4/6 semanas weeks	67,00
0248	HP/ATWV-080S1	190x190x135	HP Thermal Insulation Wave Satin 1L	Neutro satinado satined	Ondulado Wavy	3 156 52	5,40 16,40 883	Europa	4/6 semanas weeks	65,00
0249	HP/ATCW-080S2	190x190x135	HP Thermal Insulation Clear View Satin 2L	Neutro satinado satined	Liso transparente Clear smooth	3 156 52	5,40 16,40 883	Europa	4/6 semanas weeks	69,00
0250	HP/ATCW-080S1	190x190x135	HP Thermal Insulation Clear View Satin 1L	Neutro satinado satined	Liso transparente Clear smooth	3 156 52	5,40 16,40 883	Europa	4/6 semanas weeks	67,00

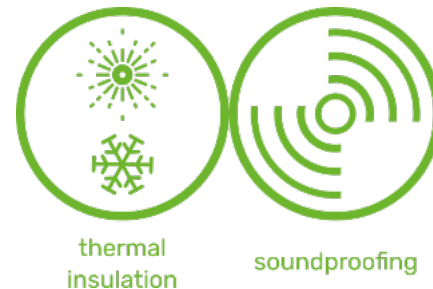

UG W/m²K 0,8

K HIGH PERFORMANCE: AISLAMIENTO TÉRMICO EASY = UG W/m²K 1,2 THERMAL INSULATION EASY = UG W/m²K 1,2

Recomendación de almacenamiento: conservar en un lugar ventilado, fresco y seco. | Storage recommendation: store in a ventilated, cool and dry place.

K1 MM 190X190X135: HP AISLAMIENTO TÉRMICO TRANSPARENTE EASY | HP CLEAR THERMAL INSULATION EASY > Ug W/m²K 1,2

Código Code	Dimensiones Dimensions MM X MM	Descripción Description	Color Colour	Acabado Finishing	Pzas. x caja Pcs. x box	Kgs. x pza. Kg. x pc.	Origen material Material origin	Plazo de entrega Delivery term	Euro pza. por caja completa Euro pc. for full box + IVA / TVA	
0251	HP/ATIS-12	190x190x120	HP Thermal Insulation IS	Transparente Clear	Cruzado Cross ribbed	3 156 52	5,00 15,20 820	Europa	3/5 semanas weeks	51,50
0252	HP/ATBB-12	190x190x120	HP Thermal Insulation Bubble	Transparente Clear	Grabados Engraved	3 156 52	5,00 15,20 820	Europa	3/5 semanas weeks	51,50
0252A	HP/ATNR-12	190x190x120	HP Thermal Insulation Ice	Transparente Clear	Satinado interior Interior satin	3 156 52	5,00 15,20 820	Europa	3/5 semanas weeks	51,50
0252B	HP/ATRD-12	190x190x120	HP Thermal Insulation Ronde	Transparente Clear	Grabados Engraved	3 156 52	5,00 15,20 820	Europa	3/5 semanas weeks	51,50
0253	HP/ATWV-12	190x190x120	HP Thermal Insulation Wave	Transparente Clear	Ondulado Wavy	3 156 52	5,00 15,20 820	Europa	3/5 semanas weeks	50,50
0254	HP/ATCW-12	190x190x120	HP Thermal Insulation Clear View	Transparente Clear	Liso transparente Clear smooth	3 156 52	5,00 15,20 820	Europa	3/5 semanas weeks	51,50

K2 MM 190X190X120: HP AISLAMIENTO TÉRMICO SATINADO EASY | HP SATIN THERMAL INSULATION EASY > UG W/M²K 1,2

0255	HP/ATIS-12S2	190x190x120	HP Thermal Insulation IS Satin 2L	Neutro satinado satined	Cruzado Cross ribbed	3 156 52	5,00 15,20 820	Europa	4/6 semanas weeks	59,50
0256	HP/ATIS-12S1	190x190x120	HP Thermal Insulation IS Satin 1L	Neutro satinado satined	Cruzado Cross ribbed	3 156 52	5,00 15,20 820	Europa	4/6 semanas weeks	57,50
0257	HP/ATBB-12S2	190x190x120	HP Thermal Insulation Bubble Satin 2L	Neutro satinado satined	Grabados Engraved	3 156 52	5,00 15,20 820	Europa	4/6 semanas weeks	59,50
0258	HP/ATRD-12S2	190x190x120	HP Thermal Insulation Ronde Satin 2L	Neutro satinado satined	Grabados Engraved	3 156 52	5,00 15,20 820	Europa	4/6 semanas weeks	59,50
0259	HP/ATWV-12S2	190x190x120	HP Thermal Insulation Wave Satin 2L	Neutro satinado satined	Ondulado Wavy	3 156 52	5,00 15,20 820	Europa	4/6 semanas weeks	57,50
0260	HP/ATWV-12S1	190x190x120	HP Thermal Insulation Wave Satin 1L	Neutro satinado satined	Ondulado Wavy	3 156 52	5,00 15,20 820	Europa	4/6 semanas weeks	55,50
0261	HP/ATCW-12S2	190x190x120	HP Thermal Insulation Clear View Satin 2L	Neutro satinado satined	Liso transparente Clear smooth	3 156 52	5,00 15,20 820	Europa	4/6 semanas weeks	59,50
0262	HP/ATCW-12S1	190x190x120	HP Thermal Insulation Clear View Satin 1L	Neutro satinado satined	Liso transparente Clear smooth	3 156 52	5,00 15,20 820	Europa	4/6 semanas weeks	57,50

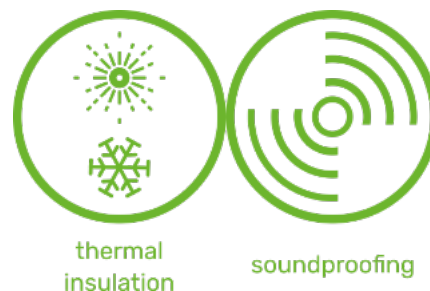

UG W/m²K 1,2

L HIGH PERFORMANCE: AISLAMIENTO TÉRMICO LIGHT = UG W/M²K 1,0 THERMAL INSULATION LIGHT = UG W/m²K 1,0

Recomendación de almacenamiento: conservar en un lugar ventilado, fresco y seco. | Storage recommendation: store in a ventilated, cool and dry place.

L1 MM 190X190X80: HP AISLAMIENTO TÉRMICO TRANSPARENTE LIGHT | HP CLEAR THERMAL INSULATION LIGHT > Ug W/m²K 1,0

	Código Code	Dimensiones Dimensions MM X MM	Descripción Description	Color Colour	Acabado Finishing	Pzas. x caja Pcs. x box	Kgs. x pza. Kg. x pc.	Origen material Material origin	Plazo de entrega Delivery term	Euro pza. por caja completa Euro pc. for full box + IVA / TVA
0263	HP/ATIS-10	190x190x80	HP Thermal Insulation IS	Transparente Clear	Cruzado Cross ribbed	5 360 72	2,80 14,50 1044	Europa	3/5 semanas weeks	51,50
0264	HP/ATBB-10	190x190x80	HP Thermal Insulation Bubble	Transparente Clear	Grabados Engraved	5 360 72	2,80 14,50 1044	Europa	3/5 semanas weeks	51,50
0264A	HP/ATNR-10	190x190x80	HP Thermal Insulation Ice	Transparente Clear	Satinado interior Interior satin	5 360 72	2,80 14,50 1044	Europa	3/5 semanas weeks	51,50
0264B	HP/ATRD-10	190x190x80	HP Thermal Insulation Ronde	Transparente Clear	Grabados Engraved	5 360 72	2,80 14,50 1044	Europa	3/5 semanas weeks	51,50
0265	HP/ATWV-10	190x190x80	HP Thermal Insulation Wave	Transparente Clear	Ondulado Wavy	5 360 72	2,80 14,50 1044	Europa	3/5 semanas weeks	50,50
0266	HP/ATCW-10	190x190x80	HP Thermal Insulation Clear View	Transparente Clear	Liso Transparente Clear Smooth	5 360 72	2,80 14,50 1044	Europa	3/5 semanas weeks	51,50

L2 MM 190X190X80: HP AISLAMIENTO TÉRMICO SATINADO LIGHT | HP SATIN THERMAL INSULATION LIGHT > UG W/M²K 1,0

0267	HP/ATIS-10S2	190x190x80	HP Thermal Insulation IS Satin 2L	Neutro satinado satined	Cruzado Cross ribbed	5 360 72	2,80 14,50 1044	Europa	4/6 semanas weeks	59,50
0268	HP/ATIS-10S1	190x190x80	HP Thermal Insulation IS Satin 1L	Neutro satinado satined	Cruzado Cross ribbed	5 360 72	2,80 14,50 1044	Europa	4/6 semanas weeks	57,50
0269	HP/ATBB-10S2	190x190x80	HP Thermal Insulation Bubble Satin 2L	Neutro satinado satined	Grabados Engraved	5 360 72	2,80 14,50 1044	Europa	4/6 semanas weeks	59,50
0270	HP/ATRD-10S2	190x190x80	HP Thermal Insulation Ronde Satin 2L	Neutro satinado satined	Grabados Engraved	5 360 72	2,80 14,50 1044	Europa	4/6 semanas weeks	59,50
0271	HP/ATWV-10S2	190x190x80	HP Thermal Insulation Wave Satin 2L	Neutro satinado satined	Ondulado Wavy	5 360 72	2,80 14,50 1044	Europa	4/6 semanas weeks	57,50
0272	HP/ATWV-10S1	190x190x80	HP Thermal Insulation Wave Satin 1L	Neutro satinado satined	Ondulado Wavy	5 360 72	2,80 14,50 1044	Europa	4/6 semanas weeks	55,50
0273	HP/ATCW-10S2	190x190x80	HP Thermal Insulation Clear View Satin 2L	Neutro satinado satined	Liso transparente Clear smooth	5 360 72	2,80 14,50 1044	Europa	4/6 semanas weeks	59,50
0274	HP/ATCW-10S1	190x190x80	HP Thermal Insulation Clear View Satin 1L	Neutro satinado satined	Liso transparente Clear smooth	5 360 72	2,80 14,50 1044	Europa	4/6 semanas weeks	57,50

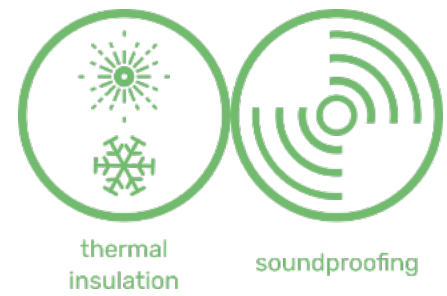

UG W/m²K 1,0

M HIGH PERFORMANCE: ANTIBALAS | BULLET RESISTANCE

M1 MM 190X190X80: HP ANTIBALAS | HP BULLET RESISTANCE

	Código Code	Dimensiones Dimensions MM X MM	Descripción Description	Color Colour	Acabado Finishing	Pzas. x caja Pcs. x box	Kgs. x pza. Kg. x pc.	Origen material Material origin	Plazo de entrega Delivery term	Euro pza. por caja completa Euro pc. for full box + IVA / TVA
						Pzas. x palet Pcs x pallet	Kgs. x caja Kg. x box			
						Caja x palet Box x pallet	Kgs. x palet Kg. x pallet			
0275	HP/BRAB-LRW	190x190x80	Ondulado Transparente	Transparente Clear	Ondulado Wavy	5 -- --	4,00 20,00 --	Europa	2/3 semanas weeks	43,00
0276	HP/BRAB-LRC	190x190x80	Liso Transparente	Transparente Clear	Liso transparente Clear smooth	5 -- --	4,00 20,00 --	Europa	2/3 semanas weeks	43,00
				*Bajo pedido disponible en versión satinado						
				*On request available in satin version						



N HIGH PERFORMANCE: AISLAMIENTO ACÚSTICO | SOUND PROOFING

N1 MM 190X190X80: HP AISLAMIENTO ACÚSTICO | HP SOUND PROOFING

	Código Code	Dimensiones Dimensions MM X MM	Descripción Description	Color Colour	Acabado Finishing	Pzas. x caja Pcs. x box Pzas. x palet Pcs x pallet Caja x palet Box x pallet	Kgs. x pza. Kg. x pc. Kgs. x caja Kg. x box Kgs. x palet Kg. x pallet	Origen material Material origin	Plazo de entrega Delivery term	Euro pza. por caja completa Euro pc. for full box + IVA / TVA
0277	HPAR/FWV	190x190x80	Ondulado Transparente	Transparente Clear	Ondulado Wavy	6 252 42	— — —	Europa	2/3 semanas weeks	19,90
0278	HPAR/FCV	190x190x80	Liso Transparente	Transparente Clear	Liso transparente Clear smooth	6 252 42	— — —	Europa	2/3 semanas weeks	
				*Bajo pedido disponible en versión satinado		*On request available in satin version				



45_{db}

O PERFORMANCE ROAD: PEATONALES Y SISTEMA MULTIPLO

O1 PERFORMANCE ROAD: PEATONALES Y SISTEMA MULTIPLO

	Código Code	Dimensiones Dimensions MM X MM	Descripción Description	Color Colour	Acabado Finishing	Pzas. x caja Pcs. x box Pzas. x palet Pcs x pallet Caja x palet Box x pallet	Kgs. x pza. Kg. x pc. Kgs. x caja Kg. x box Kgs. x palet Kg. x pallet	Origen material Material origin	Plazo de entrega Delivery term	Euro pza. x palet completo Euro pc. x full pallet + IVA / TVA	Euro pza. x caja completa Euro pc. x full box + IVA / TVA
0279	P/31	300x300x22	Baldosa Rex Antideslizante	Transparente Clear	Grabados Engraved	5 210 42	3,60 18,00 756	Europa	Disponibile Available	30,30	31,50
0280	BCRF/202-HD	202x202x43,5	Neutro Peatonal Taza Helice Diamante	Transparente Clear	Grabados Engraved			Europa	Bajo pedido On request	Solicitar presupuesto Ask for quote	
0281	P/20	200x200x22	Baldosa Circles 22	Transparente Clear	Grabados Engraved	10 600 60	1,90 19,00 1140	Europa	Disponibile Available	15,60	16,80
0282	BRPV/22-DD	200x200x22	Baldosa Diamante 22	Transparente Clear	Grabados Engraved	10 600 60	1,90 19,00 1140	Europa	2/3 semanas weeks	17,00	18,00
0283	BCRF/197-CR	197x197x38	Baldosa Screg 38	Transparente Clear	Grabados Engraved			Europa	Bajo pedido On request	Solicitar presupuesto Ask for quote	
0284	BCRF/194-RE	194x194x21	Baldosa Grec 21	Transparente Clear	Grabados Engraved			Europa	Bajo pedido On request	Solicitar presupuesto Ask for quote	
0285	BCRF/1910	190x190x100	*Neutro Peatonal Clear 10	Transparente Clear	Liso transparente Clear smooth	4 288 72	3,50 14,00 1008	Europa	2/3 semanas weeks	27,50	30,00
0286	BCRF/1010	190x190x100	Neutro Peatonal Doble Hielo	Transparente Clear	Grabados Engraved	4 288 72	3,50 14,00 1008	Europa	Disponibile Available	27,50	30,00
0287	BCTP/40	190x190x80	*Neutro Peatonal Doble 19 DS	Transparente Clear	Grabados Engraved	6 270 42	2,80 16,80 706	Europa	Bajo pedido On request	13,30	13,70
0288	BCRF/165-HC	165x16x25	Baldosa Helice 25	Transparente Clear	Grabados Engraved			Europa	Bajo pedido On request	Solicitar presupuesto Ask for quote	
0289	BCRF/30-RAY	150x150x80	*Neutro Peatonal Taza Stripes 15	Transparente Clear	Grabados Engraved	10 560 56	2,00 20,00 1120	Europa	Disponibile Available	15,40	16,50
0290	BCRF/24-SRP	120x120x60	*Neutro Peatonal Taza Stripes 12	Transparente Clear	Grabados Engraved	20 960 48	1,20 24,00 1152	Europa	2/3 semanas weeks	10,30	11,00
0291	BCRF/126	120x60 mm Ø	Neutro Peatonal Taza Redondo	Transparente Clear	Liso transparente Clear smooth	20 960 48	1,10 22,00 1056	Europa	Disponibile Available	10,30	11,00
0292	BCRF/126-S1	120x60 mm Ø	Neutro Peatonal Taza Redondo Satin	Neutro satinado satined	Liso Smooth	20 960 48	1,10 22,00 1056	Europa	2/3 semanas weeks	15,40	16,40
	*Bajo pedido disponible en versión satinado			*On request available in satin version							



O PERFORMANCE ROAD: PEATONALES Y SISTEMA MULTIPLO

O2 ACCESORIOS PARA CONSTRUCCIÓN DE PANELES CON PERFORMANCE ROAD: SISTEMA MÚLTIPLO | MULTIPLO SYSTEM

	Código Code	Dimensiones Dimensions MM X MM	Descripción Description	Color Colour	Acabado Finishing	Pzas. x caja Pcs. x box	Kgs. x pza. Kg. x pc.	Origen material Material origin	Plazo de entrega Delivery term	Euro pza. por caja completa Euro pc. for full box + IVA / TVA
						Pzas. x palet Pcs x pallet	Kgs. x caja Kg. x box			
						Caja x palet Box x pallet	Kgs. x palet Kg. x pallet			
0293	F-208	230x230x60	Marco de PVC	Gris medio Medium grey	Encofrado Formwork	100	0,158 15,80	Italia	Disponibile Available	5,30
0294	PR-40	177x177x40	Extensión / Alargador marco	Gris medio Medium grey	Encofrado Formwork	100	0,090 9,00	Italia	Disponibile Available	4,80
0295	J-1916	196x196x20	Adaptador de PVC	Gris medio Medium grey	Encofrado Formwork	100	0.070 7,00	Italia	Bajo pedido On request	4,80
0296	GF-200	200x200x22	Rejilla de PVC	Gris medio Medium grey	Encofrado Formwork	100	0,510 5,10	Italia	Disponibile Available	10,00
0297	F-1911	220x220x10	Marco Distanciador	Gris medio Medium grey	Encofrado Formwork	100	0,084 8,40	Italia	Bajo pedido On request	4,80

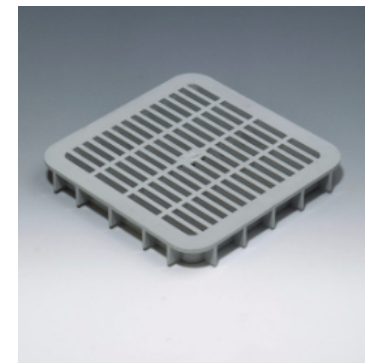
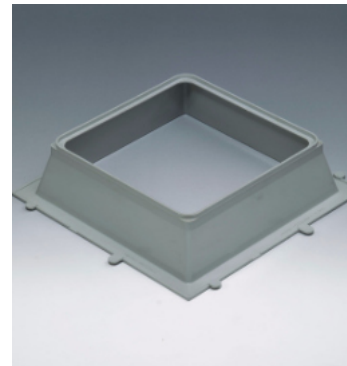
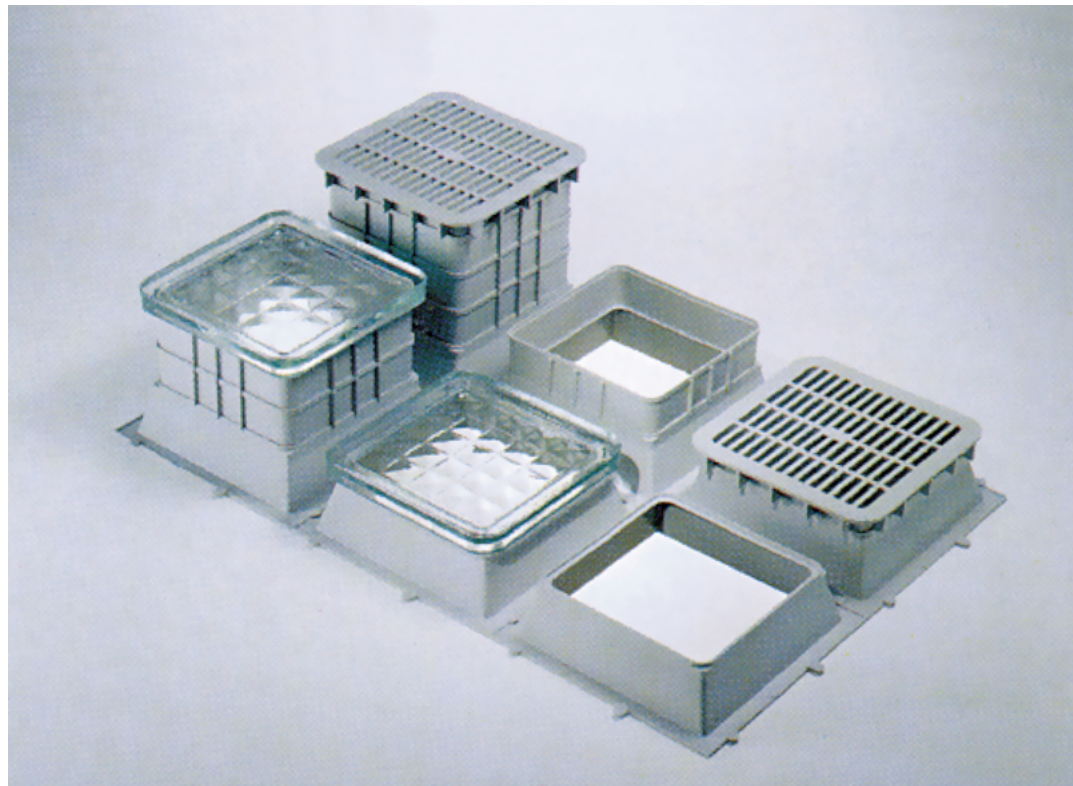

P PANEL PREFABRICADO: PANELES PREFABRICADOS DE HORMIGÓN Y VIDRIO CON DESARROLLO HORIZONTAL Y VERTICAL | VERTICAL USE

P1 PANEL DE HORMIGÓN + BLOQUE DE VIDRIO | PANEL CONCRETE + GLASS BLOCK

	Código Code	Dimensiones Dimensions MM X MM	Descripción Description	Bloque de vidrio utilizado Glass block used mm	Bloques de vidrio para panel Glass blocks for panel	Hormigón usado Used concrete	Pzas. x palet Pcs x pallet	Kgs. x pza. Kg. x pc.	Plazo de entrega Delivery term	Euro panel Euro panel + IVA / TVA
0298	PP22V	470x470	Panel con cemento y bloque de vidrio. Uso vertical	190x190x80 Ondulado / Wave	2x2 4	Blanco 4.25 Hidrofugado	24	22,00	2/3 semanas weeks	167,00
0299	PP23V	470x670	Panel con cemento y bloque de vidrio. Uso vertical	190x190x80 Ondulado / Wave	2x3 6	Blanco 4.25 Hidrofugado	24	31,00	Disponibile Available	221,00
0300	PP24V	470x870	Panel con cemento y bloque de vidrio. Uso vertical	190x190x80 Ondulado / Wave	2x4 8	Blanco 4.25 Hidrofugado	16	40,00	Disponibile Available	294,00
0301	PP25V	470x1070	Panel con cemento y bloque de vidrio. Uso vertical	190x190x80 Ondulado / Wave	2x5 10	Blanco 4.25 Hidrofugado	16	49,00	2/3 semanas weeks	340,00
0302	PP26V	470x1270	Panel con cemento y bloque de vidrio. Uso vertical	190x190x80 Ondulado / Wave	2x6 12	Blanco 4.25 Hidrofugado	10	57,00	2/3 semanas weeks	448,00
0303	PP33V	670x670	Panel con cemento y bloque de vidrio. Uso vertical	190x190x80 Ondulado / Wave	3x3 9	Blanco 4.25 Hidrofugado	16	43,00	2/3 semanas weeks	343,00
0304	PP34V	670x870	Panel con cemento y bloque de vidrio. Uso vertical	190x190x80 Ondulado / Wave	3x4 12	Blanco 4.25 Hidrofugado	10	55,00	Disponibile Available	405,00
0305	PP35V	670x1070	Panel con cemento y bloque de vidrio. Uso vertical	190x190x80 Ondulado / Wave	3x5 15	Blanco 4.25 Hidrofugado	10	66,00	Disponibile Available	463,00
0306	PP36V	670x1270	Panel con cemento y bloque de vidrio. Uso vertical	190x190x80 Ondulado / Wave	3x6 18	Blanco 4.25 Hidrofugado	10	78,00	2/3 semanas weeks	610,00
0307	PP44V	870x870	Panel con cemento y bloque de vidrio. Uso vertical	190x190x80 Ondulado / Wave	4x4 16	Blanco 4.25 Hidrofugado	10	70,00	Disponibile Available	525,00
0308	PP45V	870x1070	Panel con cemento y bloque de vidrio. Uso vertical	190x190x80 Ondulado / Wave	4x5 20	Blanco 4.25 Hidrofugado	10	86,00	Disponibile Available	659,00
0309	PP46V	87x1270	Panel con cemento y bloque de vidrio. Uso vertical	190x190x80 Ondulado / Wave	4x6 24	Blanco 4.25 Hidrofugado	8	102,00	2/3 semanas weeks	775,00



Q PAVE DE VIDRIO PISABLE PARA EXTERIORES CON CAPTADORES FOTOVOLTAICOS | SPECIAL

Q1 MM 198X198X58: BLOQUE DE VIDRIO LUMINOSO PARA EXTERIORES | LUMINOUS GLASS BLOCK FOR OUTDOORS

Código Code	Dimensiones Dimensions MM X MM	Descripción Description	Color Colour	Acabado Finishing	Pzas. x caja Pcs. x box	Kgs. x pza. Kg. x pc.	Origen material Material origin	Plazo de entrega Delivery term	Euro pza. por caja completa Euro pc. for full box + IVA / TVA	
					Pzas. x palet Pcs x pallet	Kgs. x caja Kg. x box				Caja x palet Box x pallet
0310	PPRF/198-4L	198x198x58	Lumi-Sol 198-4	Transparente Clear	Antidelizante Anti-slip	2 288 144	4,00 8,00 1152	Europa	Disponible Available	82,00

Q2 LUPA DE CRISTAL PARA ILUMINACIÓN NATURAL | GLASS LENS FOR NATURAL LIGHTING

0311	LNSLR/45	45X65 Ø	Glass Lens	Transparente Clear	Transparente Clear	30 2520 84	0,10 3,00 252	Europa	Disponible Available	9,80
------	----------	---------	------------	----------------------	----------------------	----------------	-------------------	--------	------------------------	------



R TEJA DE VIDRIO | GLASS ROOF TILE

R1 TEJA DE VIDRIO TRADICIONAL | TRADITIONAL GLASS ROOF TILE

	Código Code	Dimensiones Dimensions MM X MM	Descripción Description	Color Colour	Acabado Finishing	Pzas. x caja Pcs. x box Pzas. x palet Pcs x pallet Caja x palet Box x pallet	Kgs. x pza. Kg. x pc. Kgs. x caja Kg. x box Kgs. x palet Kg. x pallet	Origen material Material origin	Plazo de entrega Delivery term	Euro pza. por caja completa Euro pc. for full box + IVA / TVA
0312	TLR511	255x426	Teja de Vidrio Marsellesa pc. 13,5/m2	Transparente Clear	Vidrio recocido Annealed glass	8 256 32	3,70 29,60 947	Europa	Disponible Available	35,70
0313	TLR007B	270x425	Teja de Cristal Romana pc. 13,2/m2	Transparente Clear	Vidrio recocido Annealed glass	8 256 32	4,20 33,60 1075	Europa	Disponible Available	37,70
0314	TLR116	195/152x470	Teja de Cristal Acanalada - pc. 22>25/m2	Transparente Clear	Vidrio recocido Annealed glass	8 400 50	2,70 21,60 1080	Europa	Disponible Available	33,50

R2 TEJA DE VIDRIO PARA CUBIERTA: OTRAS MEDIDAS Y FORMATOS | GLASS TILE FOR ROOF: OTHER SIZES AND FORMATS

0315	TLR-70010	165x250/275	Teja de vidrio Glass roof tile - pc. 65>75/m2	Transparente Clear	Vidrio recocido Annealed glass	20 1080 54	1,20 24,00 1296	Europa	2/3 semanas weeks	15,46
0316	TLR-70030	180x345/380	Teja de vidrio Glass roof tile - pc. 40/m2	Transparente Clear	Vidrio recocido Annealed glass	10 660 66	2,20 17,60 563	Europa	2/3 semanas weeks	25,85
0317	TLR-70040*	225x313	Teja de vidrio Glass roof tile - pc. 22/m2	Transparente Clear	Vidrio recocido Annealed glass	10 450 45	2,10 21,00 945	Europa	2/3 semanas weeks	37,17
0318	TLR-70060	210x300	Teja de vidrio Glass roof tile - pc. 22/m2	Transparente Clear	Vidrio recocido Annealed glass	10 450 45	1,70 17,00 765	Europa	2/3 semanas weeks	30,19
0319	TLR-70070*	215x310	Teja de vidrio Glass roof tile - pc. 22/m2	Transparente Clear	Vidrio recocido Annealed glass	10 450 45	2,00 20,00 900	Europa	2/3 semanas weeks	37,17
0320	TLR-70100	245x415	Teja de vidrio Glass roof tile - pc. 12/m2	Transparente Clear	Vidrio recocido Annealed glass	8 320 40	3,30 26,40 1056	Europa	2/3 semanas weeks	50,12
0321	TLR-70120	222x405	Teja de vidrio Glass roof tile - pc. 15/m2	Transparente Clear	Vidrio recocido Annealed glass	8 320 40	3,00 24,00 960	Europa	2/3 semanas weeks	40,70
0322	TLR-70130	232x426	Teja de vidrio Glass roof tile - pc. 14/m2	Transparente Clear	Vidrio recocido Annealed glass	8 320 40	3,40 27,20 1088	Europa	2/3 semanas weeks	40,70
0323	TLR-70150*	221x310	Teja de vidrio Glass roof tile - pc. 22/m2	Transparente Clear	Vidrio recocido Annealed glass	10 450 45	2,00 22,00 990	Europa	2/3 semanas weeks	37,17
0324	TLR-70190*	235x425	Teja de vidrio Glass roof tile - pc. 15/m2	Transparente Clear	Vidrio recocido Annealed glass	10 320 32	2,90 29,00 928	Europa	2/3 semanas weeks	57,05
0325	TLR-70210	240x405	Teja de vidrio Glass roof tile - pc. 13/m2	Transparente Clear	Vidrio recocido Annealed glass	6 240 40	3,10 18,60 744	Europa	2/3 semanas weeks	57,05
0326	TLR-70230	250x445	Teja de vidrio Glass roof tile - pc. 13/m2	Transparente Clear	Vidrio recocido Annealed glass	8 256 32	3,90 31,20 999	Europa	2/3 semanas weeks	46,30
0327	TLR-70280*	250x425	Teja de vidrio Glass roof tile - pc. 13,8/m2	Transparente Clear	Vidrio recocido Annealed glass	8 320 40	3,50 28,00 1120	Europa	2/3 semanas weeks	57,05
0328	TLR-70290*	245x420	Teja de vidrio Glass roof tile - pc. 17/m2	Transparente Clear	Vidrio recocido Annealed glass	8 320 40	3,70 29,60 1184	Europa	2/3 semanas weeks	50,86
0329	TLR-70320	260x405	Teja de vidrio Glass roof tile - pc. 13,2/m2	Transparente Clear	Vidrio recocido Annealed glass	8 256 32	4,00 32,00 1024	Europa	2/3 semanas weeks	50,86
0330	TLR-70340	280x435	Teja de vidrio Glass roof tile - pc. 13,2/m2	Transparente Clear	Vidrio recocido Annealed glass	8 256 32	4,00 32,00 1024	Europa	2/3 semanas weeks	50,86
0331	TLR-70350	273x443	Teja de vidrio Glass roof tile - pc. 13,2/m2	Transparente Clear	Vidrio recocido Annealed glass	8 256 32	3,90 31,20 936	Europa	2/3 semanas weeks	50,86



R2	Código Code	Dimensiones	Descripción Description	Color Colour	Acabado Finishing	Pzas. x caja Pcs. x box	Kgs. x pza. Kg. x pc.	Origen material Material origin	Plazo de entrega Delivery term	Euro pza. por caja completa Euro pc. for full box + IVA / TVA
		Dimensions MM X MM				Pzas. x palet Pcs x pallet	Kgs. x caja Kg. x box			
0332	TLR-70360	252x415	Teja de vidrio Glass roof tile - pc. 14/m2	Transparente Clear	Vidrio recocido Annealed glass	8 256 32	3,60 28,80 922	Europa	2/3 semanas weeks	50,86
0333	TLR-70410*	255x430	Teja de vidrio Glass roof tile - pc. 13,5/m2	Transparente Clear	Vidrio recocido Annealed glass	8 256 32	3,00 24,00 768	Europa	2/3 semanas weeks	62,65
0334	TLR-70460	225x530	Teja de vidrio Glass roof tile - pc. 20/m2	Transparente Clear	Vidrio recocido Annealed glass	8 360 45	2,50 20,00 900	Europa	2/3 semanas weeks	30,19
0335	TLR-70510	220x290	Teja de vidrio Glass roof tile - pc. 21/m2	Transparente Clear	Vidrio recocido Annealed glass	10 450 45	2,00 20,00 900	Europa	2/3 semanas weeks	30,19
0336	TLR-70520	330x420	Teja de vidrio Glass roof tile - pc. 10/m2	Transparente Clear	Vidrio recocido Annealed glass	6 252 42	4,50 27,00 1134	Europa	2/3 semanas weeks	61,79
0337	TLR-70600	276x440	Teja de vidrio Glass roof tile - pc. 14/m2	Transparente Clear	Vidrio recocido Annealed glass	8 256 32	4,50 36,00 1152	Europa	2/3 semanas weeks	61,79
0338	TLR-70650	250x430	Teja de vidrio Glass roof tile - pc. 13/m2	Transparente Clear	Vidrio recocido Annealed glass	8 320 40	3,60 28,80 1152	Europa	2/3 semanas weeks	46,30
0339	TLR-70660*	265x413	Teja de vidrio Glass roof tile - pc. 12<13/m2	Transparente Clear	Vidrio recocido Annealed glass	8 256 32	3,90 31,20 999	Europa	2/3 semanas weeks	62,65
0340	TLR-70700	325x485	Teja de vidrio Glass roof tile - pc. 10/m2	Transparente Clear	Vidrio recocido Annealed glass	5 160 32	6,50 52,00 1664	Europa	2/3 semanas weeks	66,39
0341	TLR-70703	330x420	Teja de vidrio Glass roof tile - pc. 10/m2	Transparente Clear	Vidrio recocido Annealed glass	6 252 42	4,50 29,00 1218	Europa	2/3 semanas weeks	61,79
0342	TLR-70705*	310x445	Teja de vidrio Glass roof tile - pc. 9,5/m2	Transparente Clear	Vidrio recocido Annealed glass	6 192 32	5,00 30,00 960	Europa	2/3 semanas weeks	76,13
0343	TLR-70707*	310x485	Teja de vidrio Glass roof tile - pc. 10/m2	Transparente Clear	Vidrio recocido Annealed glass	5 160 32	6,10 30,50 976	Europa	2/3 semanas weeks	71,68
0344	TLR-70708	282x486	Teja de vidrio Glass roof tile - pc. 10/m2	Transparente Clear	Vidrio recocido Annealed glass	6 192 32	4,90 29,40 941	Europa	2/3 semanas weeks	61,79
0345	TLR-70709	240x350	Teja de vidrio Glass roof tile - pc. 19>20/m2	Transparente Clear	Vidrio recocido Annealed glass	8 360 45	2,70 21,60 972	Europa	2/3 semanas weeks	50,12
0346	TLR-70711	300x460	Teja de vidrio Glass roof tile - pc. 10/m2	Transparente Clear	Vidrio recocido Annealed glass	6 192 32	5,20 31,20 999	Europa	2/3 semanas weeks	61,79
0347	TLR-70712*	300x495	Teja de vidrio Glass roof tile - pc. 10/m2	Transparente Clear	Vidrio recocido Annealed glass	6 192 32	5,40 32,40 1037	Europa	2/3 semanas weeks	61,79
0348	TLR-70714	310x450	Teja de vidrio Glass roof tile - pc. 10/m2	Transparente Clear	Vidrio recocido Annealed glass	6 192 32	4,60 27,60 883	Europa	2/3 semanas weeks	56,40
0349	TLR-70715*	284x452	Teja de vidrio Glass roof tile - pc. 11,5/m2	Transparente Clear	Vidrio recocido Annealed glass	6 192 32	4,60 27,60 883	Europa	2/3 semanas weeks	76,13
0350	TLR-70716*	266x430	Teja de vidrio Glass roof tile - pc. 13,5/m2	transparente clear	Vidrio recocido Annealed glass	6 192 32	4,00 24,00 768	Europa	2/3 semanas weeks	69,48
0351	TLR-70717	306x480	Teja de vidrio Glass roof tile - pc. 10/m2	Transparente Clear	Vidrio recocido Annealed glass	6 192 32	5,40 32,40 1037	Europa	2/3 semanas weeks	61,79
0352	TLR-70722	305x460	Teja de vidrio Glass roof tile - pc. 10>13/m2	Transparente Clear	Vidrio recocido Annealed glass	8 256 32	4,40 35,20 1127	Europa	2/3 semanas weeks	61,82
0353	TLR-70746	270x446	Teja de vidrio Glass roof tile - pc. 13/m2	Transparente Clear	Vidrio recocido Annealed glass	8 256 32	4,20 33,60 1075	Europa	2/3 semanas weeks	56,40
0354	TLR-70748	236x315	Teja de vidrio Glass roof tile - pc. 20,5/m2	Transparente Clear	Vidrio recocido Annealed glass	8 256 32	2,20 17,60 563	Europa	2/3 semanas weeks	37,17
0355	TLR-70749	281x445	Teja de vidrio Glass roof tile - pc. 12/m2	Transparente Clear	Vidrio recocido Annealed glass	8 256 32	4,50 36,00 1152	Europa	2/3 semanas weeks	56,24
0356	TLR-70800*	265x407	Teja de vidrio Glass roof tile - pc. 13/m2	Transparente Clear	Vidrio recocido Annealed glass	8 256 32	3,50 28,00 896	Europa	2/3 semanas weeks	62,65
0357	TLR-70830	275x443	Teja de vidrio Glass roof tile - pc. 10,7/m2	Transparente Clear	Vidrio recocido Annealed glass	8 256 32	4,00 32,00 1024	Europa	2/3 semanas weeks	56,40
0358	TLR-70860	221x310	Teja de vidrio Glass roof tile - pc. 20/m2	Transparente Clear	Vidrio recocido Annealed glass	10 450 45	2,40 24,00 1080	Europa	2/3 semanas weeks	37,17
0359	TLR-70870*	250x430	Teja de vidrio Glass roof tile - pc. 13/m2	Transparente Clear	Vidrio recocido Annealed glass	8 320 40	3,70 27,20 1088	Europa	2/3 semanas weeks	62,65
0360	TLR-70881	315x495	Teja de vidrio Glass roof tile - pc. 10/m2	Transparente Clear	Vidrio recocido Annealed glass	5 160 32	6,30 31,50 1008	Europa	2/3 semanas weeks	62,31

*Venta hasta fin de existencias | Sale while stocks last - Dada la gran cantidad de modelos de tejas de vidrio, es posible que algunos artículos no estén disponibles de inmediato. Los retrasos pueden variar de 2 a 10 semanas. Preguntar siempre por la disponibilidad antes de enviar un pedido | Given the large number of roof glass tile models, it is possible that some items are not immediately available. Delays could vary from 2 to 10 weeks. Always ask for availability before sending your order.

S GLASS COVER - PERFIL DE ALUMINIO GLASS COVER - ALUMINIUM PROFILE

S1 PERFIL EN ALUMINIO CURVO Y RECTANGULAR PARA EL REMATE FINAL DE PAREDES INTERIORES DE BLOQUE DE VIDRIO CURVED AND RECTANGULAR ALUMINIUM PROFILE FOR THE FINAL ROW OF WALLS INTERIORS OF GLASS BLOCK

	Código Code	Dimensiones Dimensions MM X MM	Descripción Description	Color Colour	Acabado Finishing	Pzas. x caja Pcs. x box Pzas. x palet Pcs x pallet Caja x palet Box x pallet	Kgs. x pza. Kg. x pc. Kgs. x caja Kg. x box Kgs. x palet Kg. x pallet	Origen material Material origin	Plazo de entrega Delivery term	Euro pza. por caja completa Euro pc. for full box + IVA / TVA
0361	PAB-100CV	mm 1000	Perfil curvo en aluminio brillo 100 cm	Aluminio Aluminum	Brillo Glossy	10	0,40 4,00	España	Disponibile Available	22,50
0362	PAB-200CV	mm 2000	Perfil curvo en aluminio brillo 200 cm	Aluminio Aluminum	Brillo Glossy	10	0,80 8,00	España	Disponibile Available	45,00
0363	PAB-250CV	mm 2500	Perfil curvo en aluminio brillo 250 cm	Aluminio Aluminum	Brillo Glossy	10	1,00 10,00	España	Disponibile Available	55,00
0364	PAB-100QD	mm 1000	Perfil rectang. en alum. brillo 100 cm	Aluminio Aluminum	Brillo Glossy	10	0,31 3,10	España	Disponibile Available	17,50
0365	PAB-200QD	mm 2000	Perfil rectang. en alum. brillo 200 cm	Aluminio Aluminum	Brillo Glossy	10	0,62 6,20	España	Disponibile Available	32,50
0366	PAB-250QD	mm 2500	Perfil rectang. en alum. brillo 250 cm	Aluminio Aluminum	Brillo Glossy	10	0,77 7,70	España	Disponibile Available	41,50
0367	PAS-100CV	mm 1000	Perfil curvo en aluminio mate 100 cm	Aluminio Aluminum	Mate Matt	10	0,40 4,00	España	Disponibile Available	19,50
0368	PAS-200CV	mm 2000	Perfil curvo en aluminio mate 200 cm	Aluminio Aluminum	Mate Matt	10	0,80 8,00	España	Disponibile Available	36,00
0369	PAS-250CV	mm 2500	Perfil curvo en aluminio mate 250 cm	Aluminio Aluminum	Mate Matt	10	1,00 10,00	España	Disponibile Available	40,00
0370	PAS-100QD	mm 1000	Perfil rectang. en aluminio mate 100 cm	Aluminio Aluminum	Mate Matt	10	0,31 3,10	España	Disponibile Available	16,00
0371	PAS-200QD	mm 2000	Perfil rectang. en aluminio mate 200 cm	Aluminio Aluminum	Mate Matt	10	0,62 6,20	España	Disponibile Available	28,50
0372	PAS-250QD	mm 2500	Perfil rectang. en aluminio mate 250 cm	Aluminio Aluminum	Mate Matt	10	0,77 7,70	España	Disponibile Available	32,50
0373	PAW-100CV	mm 1000	Perfil curvo alum. lacado blanco 100 cm	Aluminio Aluminum	Lacado Lacquered	10	0,40 4,00	España	Disponibile Available	19,50
0374	PAW-200CV	mm 2000	Perfil curvo alum. lacado blanco 200 cm	Aluminio Aluminum	Lacado Lacquered	10	0,80 8,00	España	Disponibile Available	36,00
0375	PAW-250CV	mm 2500	Perfil curvo alum. lacado blanco 250 cm	Aluminio Aluminum	Lacado Lacquered	10	1,00 10,00	España	Disponibile Available	40,00
0376	PAW-100QD	mm 1000	Perfil rectang. alum. lacado blanco 100 cm	Aluminio Aluminum	Lacado Lacquered	10	0,31 3,10	España	Disponibile Available	16,00
0377	PAW-200QD	mm 2000	Perfil rectang. alum. lacado blanco 200 cm	Aluminio Aluminum	Lacado Lacquered	10	0,62 6,20	España	Disponibile Available	28,50
0378	PAW-250QD	mm 2500	Perfil rectang. alum. lacado blanco 250 cm	Aluminio Aluminum	Lacado Lacquered	10	0,77 7,70	España	Disponibile Available	32,50

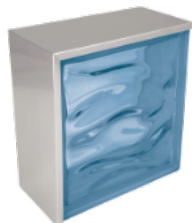



T EOLO: VENTANA DE VENTILACIÓN CON DOBLE CRISTAL Y MALLA ANTI MOSQUITOS INCORPORADA | VENTILATION WINDOWS

T1 VENTANA DE VENTILACIÓN CON CRISTAL Y MALLA MOSQUITERA | VENTILATION WINDOWS WITH GLASS AND MOSQUITO NET

	Código Code	Dimensiones Dimensions MM X MM	Descripción Description	Color Colour	Acabado Finishing	Pzas. x caja Pcs. x box	Kgs. x pza. Kg. x pc.	Origen material Material origin	Plazo de entrega Delivery term	Euro pza. por caja completa Euro pc. for full box + IVA / TVA
						Pzas. x palet Pcs x pallet	Kgs. x caja Kg. x box			
						Caja x palet Box x pallet	Kgs. x palet Kg. x pallet			
0379	62CA1919W	190x190x80	1/19 Eolo White	Blanco White	PVC + Aluminum + Glass + Fiber Net	1	0,90	Import	Disponibile Available	72,50
0380	62CA2424W	240x240x80	1/24 Eolo White	Blanco White	PVC + Aluminum + Glass + Fiber Net	1	1,20	Import	Disponibile Available	89,50
0381	62CA3030W	300x300x100	1/30 Eolo White	Blanco White	PVC + Aluminum + Glass + Fiber Net	1	1,80	Import	Disponibile Available	107,00
0382	62CA1938W	190x380x80	2/19 Eolo White	Blanco White	PVC + Aluminum + Glass + Fiber Net	1	1,50	Import	Disponibile Available	89,50
0383	62CA3819W	389x190x80	2/19 Eolo White	Blanco White	PVC + Aluminum + Glass + Fiber Net	1	1,50	Import	Disponibile Available	72,50
0384	62CA5719W	570x190x80	3/19 Eolo White	Blanco White	PVC + Aluminum + Glass + Fiber Net	1	2,20	Import	Disponibile Available	94,00
0385	62CA3838W	380x380x80	4/19 Eolo White	Blanco White	PVC + Aluminum + Glass + Fiber Net	1	3,20	Import	Disponibile Available	94,50
0386	62CA4824W	480x240x80	2/24 Eolo White	Blanco White	PVC + Aluminum + Glass + Fiber Net	1	2,20	Import	Disponibile Available	94,00
0387	62CA4848W	480x480x80	4/24 Eolo White	Blanco White	PVC + Aluminum + Glass + Fiber Net	1	3,50	Import	Disponibile Available	116,00
0388	62CA5738W	570x380x80	3/19 Eolo White	Blanco White	PVC + Aluminum + Glass + Fiber Net	1	3,50	Import	Disponibile Available	110,00

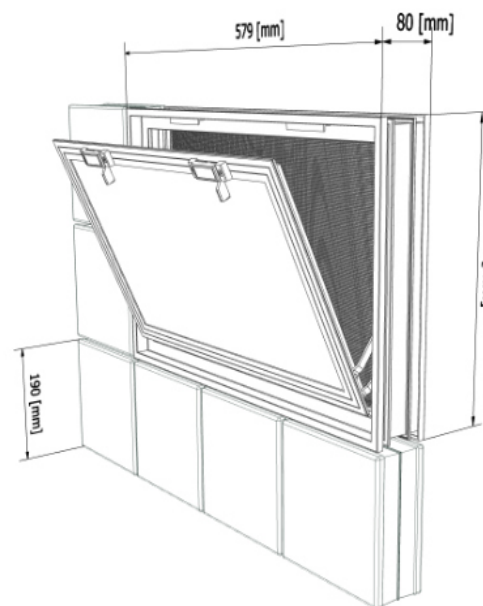
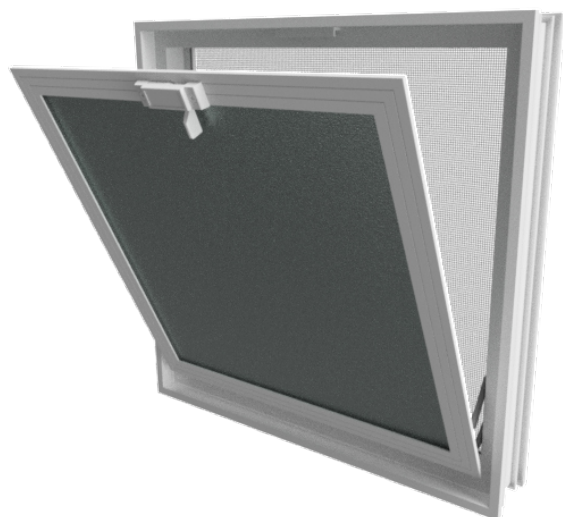

U BLIZZARD: VENTANA BASCULANTE | TILTING WINDOWS

U1 MARCO BASCULANTE EN ACERO GALVANIZADO PARA BLOQUE DE VIDRIO | TILTING FRAME IN GALVANIZED STEEL FOR GLASS BLOCK

	Código Code	Dimensiones Dimensions MM X MM	Descripción Description	Color Colour	Acabado Finishing	Pzas. x caja Pcs. x box	Kgs. x pza. Kg. x pc.	Origen material Material origin	Plazo de entrega Delivery term	Euro pza. Euro pc. + IVA / TVA
						Pzas. x palet Pcs x pallet	Kgs. x caja Kg. x box			
						Caja x palet Box x pallet	Kgs. x palet Kg. x pallet			
0389	FP191	215x225x80	Ventana basculante para 1 bloque de 19x19x8 cm	Blanco White	Acero lacado Lacquered steel	1	1,50	Europa	Disponibile Available	53,00
0390	FP192	215x425x80	Ventana basculante para 2 bloques de 19x19x8 cm	Blanco White	Acero lacado Lacquered steel	1	2,50	Europa	Disponibile Available	63,50
0391	FP194	425x425x80	Ventana basculante para 4 bloques de 19x19x8 cm	Blanco White	Acero lacado Lacquered steel	1	4,00	Europa	Disponibile Available	85,00
0392	FP241	265x280x80	Ventana basculante para 1 bloque de 24x24x8 cm	Blanco White	Acero lacado Lacquered steel	1	2,70	Europa	Disponibile Available	72,50
0393	FP242	265x530x80	Ventana basculante para 2 bloques de 24x24x8 cm	Blanco White	Acero lacado Lacquered steel	1	3,30	Europa	Disponibile Available	96,00
0394	FP244	520x530x80	Ventana basculante para 4 bloques de 24x24x8 cm	Blanco White	Acero lacado Lacquered steel	1	4,80	Europa	Disponibile Available	144,00
0395	BVLR/02CT	190x190x80	Ventana Cefiro	Transparente Clear		1	3,30	Europa	Disponibile Available	42,00
0396	OMLR/19	185x70x9	Tapa Ventilación Cefiro	Transparente Clear		1		Europa	Disponibile Available	28,00

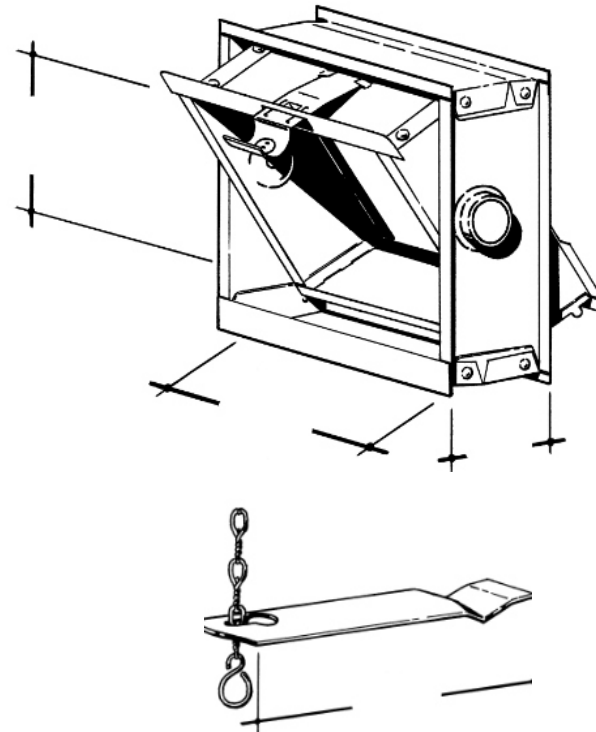

V ACCESORIOS | ACCESSORIES

V1 ACCESORIOS PARA LA INSTALACIÓN DE BLOQUE DE VIDRIO | ACCESSORIES FOR INSTALLING GLASS BLOCK

	Código Code	Dimensiones Dimensions MM X MM	Descripción Description	Color Colour	Acabado Finishing	Pzas. x caja Pcs. x box Pzas. x palet Pcs x pallet Caja x palet Box x pallet	Kgs. x pza. Kg. x pc. Kgs. x caja Kg. x box Kgs. x palet Kg. x pallet	Origen material Material origin	Plazo de entrega Delivery term	Euro pza. por caja completa Euro pc. for full box + IVA / TVA
0397	GLASSBOND/25	Saco Kg 25	Cemento-cola Glassbond 25 saco de 25 Kg	Blanco White	Blanco White	Palet de 32 sacos	25 800	España	Disponibile Available	23,80
0398	GLASSBOND/12	Saco Kg 12	Cemento-cola Glassbond 12 saco de 12 Kg	Blanco White	Blanco White	Palet de 32 sacos	12 384	España	Disponibile Available	16,50
0399	MPA/B-10	Bobina 10 ml	Junta de dilatación perimetral mm 1000x60x80	Bicolor Two tone	Adhesivo bicolor Adhesive two- tone	Caja de 10 bobinas	0,80 8,00	Italia	Disponibile Available	22,00
0400	DPB08/200	Bolsa de 200 pz	Distanciador para bloques de vidrio (bolsa de 200 uds.)	Blanco - gris White - grey	Blanco - gris White - grey	Caja de 3 bolsas = 600 pzas.	0,80 8,00	Italia	Disponibile Available	0,25
0401	TXA/006	Varilla de 200 cm	Varilla inox Aisi 304 corrugada 6 mm diám. en barra de 2 mtl	Acero Inox	Acero Inox	Bulto de 10 varillas	0,50 5,00	Italia	Disponibile Available	12,40
0402	TXA/005	Varilla de 100 cm	Varilla inox Aisi 304 corrugada 6 mm diám. en barra de 1 mtl	Acero Inox	Acero Inox	Bulto de 10 varillas	0,45 4,50	Italia	Disponibile Available	7,20
0403	TXG/006	Varilla de 200 cm	Varilla galvanizada lisa 6 mm diám. en barra de 2 mtl	Acero Inox	Acero Inox	Bulto de 10 varillas	0,25 2,50	España	Disponibile Available	4,50
0404	TXG/005	Varilla de 100 cm	Varilla galvanizada lisa 6 mm diám. en barra de 1 mtl	Acero Inox	Acero Inox	Bulto de 10 varillas	0,20 2,00	España	Disponibile Available	2,70
0405	LLX/C-750	750 ml	Limpiador Lux Glass ml 750			Caja con 12 pzas.	0,75 9,00	Italia	Disponibile Available	13,00



W READYBLOCK SYSTEM

W1 SISTEMA MODULAR EN ALUMINIO PARA BLOQUE DE VIDRIO | MODULAR SYSTEM IN ALUMINUM FOR GLASS BLOCK

	Código Code	Dimensiones Dimensions MM X MM	Descripción Description	Color Colour	Acabado Finishing	Pzas. x caja Pcs. x box	Kgs. x pza. Kg. x pc. Kgs. x caja Kg. x box	Origen material Material origin	Plazo de entrega Delivery term	Euro pza. por caja completa Euro pc. for full box + IVA / TVA
0406	ARS-E01		ReadyBlock - Fijación lateral	Aluminio mate Satin aluminum	Aluminio mate Satin aluminum	10	0,80 8,00	Italia	Disponibile Available	1,35
0407	ARS-H19	H/190	ReadyBlock - Separación vertical cm 19	Aluminio mate Satin aluminum	Aluminio mate Satin aluminum	10	0,05 0,50	España	Disponibile Available	1,30
0408	ARS-H24	H/240	ReadyBlock - Separación vertical cm 24	Aluminio mate Satin aluminum	Aluminio mate Satin aluminum	10	0,07 ,70	España	Disponibile Available	2,15
0409	ARS-L10	Largo Length mm 1000	ReadyBlock - Perfil Horizontal cm 100	Aluminio mate Satin aluminum	Aluminio mate Satin aluminum	10	0,277 2,770	España	Disponibile Available	6,60
0410	ARS-L20	Largo Length mm 2000	ReadyBlock - Perfil Horizontal cm 200	Aluminio mate Satin aluminum	Aluminio mate Satin aluminum	10	0,554 5,540	España	Disponibile Available	11,50
0411	ARS-L30	Largo Length mm 3000	ReadyBlock - Perfil Horizontal cm 300	Aluminio mate Satin aluminum	Aluminio mate Satin aluminum	10	0,831 8,310	España	Disponibile Available	17,40
0412	PU-80-100C	Largo Length mm 1000	ReadyBlock - Perfil Perimetral (mm 35x1000)	Aluminio mate Satin aluminum	Aluminio mate Satin aluminum	1	1,02 1,02	España	Disponibile Available	43,00
0413	PU-80-200C	Largo Length mm 2000	ReadyBlock - Perfil Perimetral (mm 35x2000)	Aluminio mate Satin aluminum	Aluminio mate Satin aluminum	1	2,04 2,04	España	Disponibile Available	82,00
0414	PU-80-300C	Largo Length mm 3000	ReadyBlock - Perfil Perimetral (mm 35x3000)	Aluminio mate Satin aluminum	Aluminio mate Satin aluminum	1	3,06 3,06	España	Disponibile Available	102,00
0415	ARS-SB1	290 ml	ReadyBlock -Silicona ReadySil 290 ml	Blanco White	Mate Matt	12	0,290 2,90	Italia	Disponibile Available	21,80

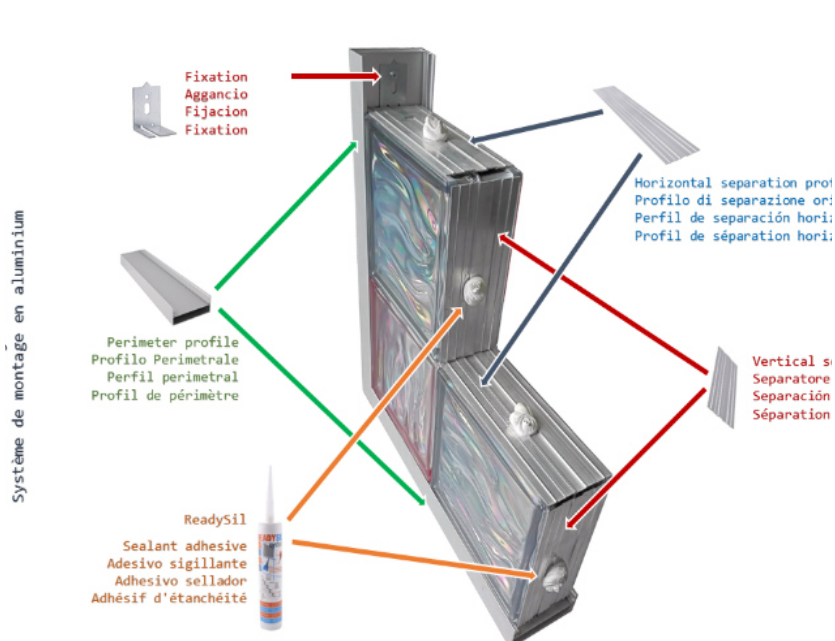

X READYBLOCK KIT

X1 KIT READYBLOCK EN ALUMINIO. PAREDES COMPLETAS CON TODOS LOS COMPONENTES Y SILICONA READYSIL BLANCA
 BLOQUE DE VIDRIO NO INCLUIDO
 READYBLOCK KIT IN ALUMINUM. COMPLETE WALLS WITH ALL THE COMPONENTS AND READYSIL WHITE SILICONE
 GLASS BLOCK NOT INCLUDED

	Código Code	Dimensiones Dimensions MM X MM	Descripción Description	Color Colour	Acabado Finishing	Kit x caja Kit per box Solo sistema, no vidrio System only, no glass block	Nº bloques de vidrio Nº glass blocks	Origen material Material origin	Plazo de entrega Delivery term	Precio PVP por pared cortada a medida, sin cristal PVP price per wall cut to size, excluding glass + IVA / TVA
0416	RB011019	264x1983	Readyblock - Kit en aluminio Kit in aluminum	Aluminio Aluminum	Aluminio mate Satin aluminum	1	1x10	España	Disponibile Available	330,46
0417	RB021019	455x1983	Readyblock - Kit en aluminio Kit in aluminum	Aluminio Aluminum	Aluminio mate Satin aluminum	1	2x10	España	Disponibile Available	369,90
0418	RB031019	646x1983	Readyblock - Kit en aluminio Kit in aluminum	Aluminio Aluminum	Aluminio mate Satin aluminum	1	3x10	España	Disponibile Available	404,75
0419	RB041019	837x1983	Readyblock - Kit en aluminio Kit in aluminum	Aluminio Aluminum	Aluminio mate Satin aluminum	1	4x10	España	Disponibile Available	445,01
0420	RB051019	1028x1983	Readyblock - Kit en aluminio Kit in aluminum	Aluminio Aluminum	Aluminio mate Satin aluminum	1	5x10	España	Disponibile Available	483,14
0421	RB061019	1219x1983	Readyblock - Kit en aluminio Kit in aluminum	Aluminio Aluminum	Aluminio mate Satin aluminum	1	6x10	España	Disponibile Available	754,40
0422	RB071019	1410x1983	Readyblock - Kit en aluminio Kit in aluminum	Aluminio Aluminum	Aluminio mate Satin aluminum	1	7x10	España	Disponibile Available	792,00
0423	RB081019	1601x1983	Readyblock - Kit en aluminio Kit in aluminum	Aluminio Aluminum	Aluminio mate Satin aluminum	1	8x10	España	Disponibile Available	799,01
0424	RB091019	1792x1983	Readyblock - Kit en aluminio Kit in aluminum	Aluminio Aluminum	Aluminio mate Satin aluminum	1	9x10	España	Disponibile Available	869,20
0425	RB101019	1983x1983	Readyblock - Kit en aluminio Kit in aluminum	Aluminio Aluminum	Aluminio mate Satin aluminum	1	10x10	España	Disponibile Available	907,33
0426	RB111019	2174x1983	Readyblock - Kit en aluminio Kit in aluminum	Aluminio Aluminum	Aluminio mate Satin aluminum	1	11x10	España	Disponibile Available	1.017,29
0427	RB121019	2365x1983	Readyblock - Kit en aluminio Kit in aluminum	Aluminio Aluminum	Aluminio mate Satin aluminum	1	12x10	España	Disponibile Available	1.055,34
0428	RB131019	2556x1983	Readyblock - Kit en aluminio Kit in aluminum	Aluminio Aluminum	Aluminio mate Satin aluminum	1	13x10	España	Disponibile Available	1.093,63
0429	RB010919	264x1792	Readyblock - Kit en aluminio Kit in aluminum	Aluminio Aluminum	Aluminio mate Satin aluminum	1	1x9	España	Disponibile Available	333,74
0430	RB020919	455x1792	Readyblock - Kit en aluminio Kit in aluminum	Aluminio Aluminum	Aluminio mate Satin aluminum	1	2x9	España	Disponibile Available	355,88
0431	RB030919	646x1792	Readyblock - Kit en aluminio Kit in aluminum	Aluminio Aluminum	Aluminio mate Satin aluminum	1	3x9	España	Disponibile Available	392,45
0432	RB040919	837x1792	Readyblock - Kit en aluminio Kit in aluminum	Aluminio Aluminum	Aluminio mate Satin aluminum	1	4x9	España	Disponibile Available	428,86
0433	RB050919	1028x1792	Readyblock - Kit en aluminio Kit in aluminum	Aluminio Aluminum	Aluminio mate Satin aluminum	1	5x9	España	Disponibile Available	465,27
0434	RB060919	1219x1792	Readyblock - Kit en aluminio Kit in aluminum	Aluminio Aluminum	Aluminio mate Satin aluminum	1	6x9	España	Disponibile Available	533,66
0435	RB070919	1410x1792	Readyblock - Kit en aluminio Kit in aluminum	Aluminio Aluminum	Aluminio mate Satin aluminum	1	7x9	España	Disponibile Available	751,94
0436	RB080919	1601x1792	Readyblock - Kit en aluminio Kit in aluminum	Aluminio Aluminum	Aluminio mate Satin aluminum	1	8x9	España	Disponibile Available	783,43
0437	RB090919	1792x1792	Readyblock - Kit en aluminio Kit in aluminum	Aluminio Aluminum	Aluminio mate Satin aluminum	1	9x9	España	Disponibile Available	819,92

X1	Código Code	Dimensiones Dimensions MM X MM	Descripción Description	Color Colour	Acabado Finishing	Kit x caja Kit per box Solo sistema, no vidrio System only, no glass block	N° bloques de vidrio N° glass blocks	Origen material Material origin	Plazo de entrega Delivery term	Precio PVP por pared cortada a medida, sin cristal PVP price per wall cut to size, excluding glass + IVA / TVA
0438	RB100919	1983x1792	Readyblock - Kit en aluminio Kit in aluminum	Aluminio Aluminum	Aluminio mate Satin aluminum	1	10x9	España	Disponibile Available	886,58
0439	RB110919	2174x1792	Readyblock - Kit en aluminio Kit in aluminum	Aluminio Aluminum	Aluminio mate Satin aluminum	1	11x9	España	Disponibile Available	938,41
0440	RB120919	2365x1792	Readyblock - Kit en aluminio Kit in aluminum	Aluminio Aluminum	Aluminio mate Satin aluminum	1	12x9	España	Disponibile Available	974,73
0441	RB130919	2556x1792	Readyblock - Kit en aluminio Kit in aluminum	Aluminio Aluminum	Aluminio mate Satin aluminum	1	13x9	España	Disponibile Available	1.031,31
0442	RB140919	2747x1792	Readyblock - Kit en aluminio Kit in aluminum	Aluminio Aluminum	Aluminio mate Satin aluminum	1	14x9	España	Disponibile Available	1.067,64
0443	RB150919	2938x1792	Readyblock - Kit en aluminio Kit in aluminum	Aluminio Aluminum	Aluminio mate Satin aluminum	1	15x9	España	Disponibile Available	1.104,05
0444	RB010819	264x1601	Readyblock - Kit en aluminio Kit in aluminum	Aluminio Aluminum	Aluminio mate Satin aluminum	1	1x8	España	Disponibile Available	288,64
0445	RB020819	455x1601	Readyblock - Kit en aluminio Kit in aluminum	Aluminio Aluminum	Aluminio mate Satin aluminum	1	2x8	España	Disponibile Available	323,36
0446	RB030819	646x1601	Readyblock - Kit en aluminio Kit in aluminum	Aluminio Aluminum	Aluminio mate Satin aluminum	1	3x8	España	Disponibile Available	357,93
0447	RB040819	837x1601	Readyblock - Kit en aluminio Kit in aluminum	Aluminio Aluminum	Aluminio mate Satin aluminum	1	4x8	España	Disponibile Available	392,45
0448	RB050819	1028x1601	Readyblock - Kit en aluminio Kit in aluminum	Aluminio Aluminum	Aluminio mate Satin aluminum	1	5x8	España	Disponibile Available	427,06
0449	RB060819	1219x1601	Readyblock - Kit en aluminio Kit in aluminum	Aluminio Aluminum	Aluminio mate Satin aluminum	1	6x8	España	Disponibile Available	489,54
0450	RB070819	1410x1601	Readyblock - Kit en aluminio Kit in aluminum	Aluminio Aluminum	Aluminio mate Satin aluminum	1	7x8	España	Disponibile Available	524,23
0451	RB080819	1601x1601	Readyblock - Kit en aluminio Kit in aluminum	Aluminio Aluminum	Aluminio mate Satin aluminum	1	8x8	España	Disponibile Available	735,87
0452	RB090819	1792x1601	Readyblock - Kit en aluminio Kit in aluminum	Aluminio Aluminum	Aluminio mate Satin aluminum	1	9x8	España	Disponibile Available	768,01
0453	RB100819	1983x1601	Readyblock - Kit en aluminio Kit in aluminum	Aluminio Aluminum	Aluminio mate Satin aluminum	1	10x8	España	Disponibile Available	804,99
0454	RB110819	2174x1601	Readyblock - Kit en aluminio Kit in aluminum	Aluminio Aluminum	Aluminio mate Satin aluminum	1	11x8	España	Disponibile Available	879,70
0455	RB120819	2365x1601	Readyblock - Kit en aluminio Kit in aluminum	Aluminio Aluminum	Aluminio mate Satin aluminum	1	12x8	España	Disponibile Available	914,30
0456	RB130819	2556x1601	Readyblock - Kit en aluminio Kit in aluminum	Aluminio Aluminum	Aluminio mate Satin aluminum	1	13x8	España	Disponibile Available	948,90
0457	RB140819	2747x1601	Readyblock - Kit en aluminio Kit in aluminum	Aluminio Aluminum	Aluminio mate Satin aluminum	1	14x8	España	Disponibile Available	983,43
0458	RB1509819	2938x1601	Readyblock - Kit en aluminio Kit in aluminum	Aluminio Aluminum	Aluminio mate Satin aluminum	1	15x8	España	Disponibile Available	1.017,95
0459	RB010719	264x1410	Readyblock - Kit en aluminio Kit in aluminum	Aluminio Aluminum	Aluminio mate Satin aluminum	1	1x7	España	Disponibile Available	277,98
0460	RB020719	455x1410	Readyblock - Kit en aluminio Kit in aluminum	Aluminio Aluminum	Aluminio mate Satin aluminum	1	2x7	España	Disponibile Available	310,78
0461	RB030719	646x1410	Readyblock - Kit en aluminio Kit in aluminum	Aluminio Aluminum	Aluminio mate Satin aluminum	1	3x7	España	Disponibile Available	343,58
0462	RB040719	837x1410	Readyblock - Kit en aluminio Kit in aluminum	Aluminio Aluminum	Aluminio mate Satin aluminum	1	4x7	España	Disponibile Available	376,38
0463	RB050719	1028x1410	Readyblock - Kit en aluminio Kit in aluminum	Aluminio Aluminum	Aluminio mate Satin aluminum	1	5x7	España	Disponibile Available	409,10
0464	RB060719	1219x1410	Readyblock - Kit en aluminio Kit in aluminum	Aluminio Aluminum	Aluminio mate Satin aluminum	1	6x7	España	Disponibile Available	465,92

X1	Código Code	Dimensiones	Descripción Description	Color Colour	Acabado Finishing	Kit x caja Kit per box	N° bloques de vidrio N° glass blocks	Origen material Material origin	Plazo de entrega Delivery term	Precio PVP por pared cortada a medida, sin cristal PVP price per wall cut to size, excluding glass + IVA / TVA
		Dimensions MM X MM				Solo sistema, no vidrio System only, no glass block				
0465	RB070719	1410x1410	Readyblock - Kit en aluminio Kit in aluminum	Aluminio Aluminum	Aluminio mate Satin aluminum	1	7x7	España	Disponibile Available	478,47
0466	RB080719	1601x1410	Readyblock - Kit en aluminio Kit in aluminum	Aluminio Aluminum	Aluminio mate Satin aluminum	1	8x7	España	Disponibile Available	511,19
0467	RB090719	1792x1410	Readyblock - Kit en aluminio Kit in aluminum	Aluminio Aluminum	Aluminio mate Satin aluminum	1	9x7	España	Disponibile Available	689,13
0468	RB100719	1984x1410	Readyblock - Kit en aluminio Kit in aluminum	Aluminio Aluminum	Aluminio mate Satin aluminum	1	10x7	España	Disponibile Available	750,71
0469	RB110719	2174x1410	Readyblock - Kit en aluminio Kit in aluminum	Aluminio Aluminum	Aluminio mate Satin aluminum	1	11x7	España	Disponibile Available	821,07
0470	RB120719	2365x1410	Readyblock - Kit en aluminio Kit in aluminum	Aluminio Aluminum	Aluminio mate Satin aluminum	1	12x7	España	Disponibile Available	853,78
0471	RB130719	2556x1410	Readyblock - Kit en aluminio Kit in aluminum	Aluminio Aluminum	Aluminio mate Satin aluminum	1	13x7	España	Disponibile Available	866,17
0472	RB140719	2747x1410	Readyblock - Kit en aluminio Kit in aluminum	Aluminio Aluminum	Aluminio mate Satin aluminum	1	14x7	España	Disponibile Available	899,13
0473	RB150719	2938x1410	Readyblock - Kit en aluminio Kit in aluminum	Aluminio Aluminum	Aluminio mate Satin aluminum	1	15x7	España	Disponibile Available	931,93
0474	RB010619	264x1219	Readyblock - Kit en aluminio Kit in aluminum	Aluminio Aluminum	Aluminio mate Satin aluminum	1	1x6	España	Disponibile Available	178,76
0475	RB020619	455x1219	Readyblock - Kit en aluminio Kit in aluminum	Aluminio Aluminum	Aluminio mate Satin aluminum	1	2x6	España	Disponibile Available	298,07
0476	RB030619	646x1219	Readyblock - Kit en aluminio Kit in aluminum	Aluminio Aluminum	Aluminio mate Satin aluminum	1	3x6	España	Disponibile Available	328,00
0477	RB040619	837x1219	Readyblock - Kit en aluminio Kit in aluminum	Aluminio Aluminum	Aluminio mate Satin aluminum	1	4x6	España	Disponibile Available	339,89
0478	RB050619	1028x1219	Readyblock - Kit en aluminio Kit in aluminum	Aluminio Aluminum	Aluminio mate Satin aluminum	1	5x6	España	Disponibile Available	370,89
0479	RB060619	1219x1219	Readyblock - Kit en aluminio Kit in aluminum	Aluminio Aluminum	Aluminio mate Satin aluminum	1	6x6	España	Disponibile Available	339,89
0480	RB070619	1410x1219	Readyblock - Kit en aluminio Kit in aluminum	Aluminio Aluminum	Aluminio mate Satin aluminum	1	7x6	España	Disponibile Available	452,89
0481	RB080619	1601x1219	Readyblock - Kit en aluminio Kit in aluminum	Aluminio Aluminum	Aluminio mate Satin aluminum	1	8x6	España	Disponibile Available	463,63
0482	RB090619	1792x1219	Readyblock - Kit en aluminio Kit in aluminum	Aluminio Aluminum	Aluminio mate Satin aluminum	1	9x6	España	Disponibile Available	494,46
0483	RB100619	1983x1219	Readyblock - Kit en aluminio Kit in aluminum	Aluminio Aluminum	Aluminio mate Satin aluminum	1	10X6	España	Disponibile Available	702,66
0484	RB110619	2174x1219	Readyblock - Kit en aluminio Kit in aluminum	Aluminio Aluminum	Aluminio mate Satin aluminum	1	11X6	España	Disponibile Available	742,10
0485	RB120619	2365x1219	Readyblock - Kit en aluminio Kit in aluminum	Aluminio Aluminum	Aluminio mate Satin aluminum	1	12X6	España	Disponibile Available	773,10
0486	RB130619	2556x1219	Readyblock - Kit en aluminio Kit in aluminum	Aluminio Aluminum	Aluminio mate Satin aluminum	1	13X6	España	Disponibile Available	804,09
0487	RB140619	2747x1219	Readyblock - Kit en aluminio Kit in aluminum	Aluminio Aluminum	Aluminio mate Satin aluminum	1	14X6	España	Disponibile Available	835,09
0488	RB150619	2938x1219	Readyblock - Kit en aluminio Kit in aluminum	Aluminio Aluminum	Aluminio mate Satin aluminum	1	15X6	España	Disponibile Available	845,83
0489	RB010519	264x1028	Readyblock - Kit en aluminio Kit in aluminum	Aluminio Aluminum	Aluminio mate Satin aluminum	1	1x5	España	Disponibile Available	167,85
0490	RB020519	455x1028	Readyblock - Kit en aluminio Kit in aluminum	Aluminio Aluminum	Aluminio mate Satin aluminum	1	2x5	España	Disponibile Available	197,05
0491	RB030519	646x1028	Readyblock - Kit en aluminio Kit in aluminum	Aluminio Aluminum	Aluminio mate Satin aluminum	1	3x5	España	Disponibile Available	294,38

X1	Código Code	Dimensiones	Descripción Description	Color Colour	Acabado Finishing	Kit x caja Kit per box	N° bloques de vidrio N° glass blocks	Origen material Material origin	Plazo de entrega Delivery term	Precio PVP por pared cortada a medida, sin cristal PVP price per wall cut to size, excluding glass + IVA / TVA
		Dimensions MM X MM				Solo sistema, no vidrio System only, no glass block				
0492	RB040519	837x1026	Readyblock - Kit en aluminio Kit in aluminum	Aluminio Aluminum	Aluminio mate Satin aluminum	1	4x5	España	Disponibile Available	323,74
0493	RB050519	1028x1028	Readyblock - Kit en aluminio Kit in aluminum	Aluminio Aluminum	Aluminio mate Satin aluminum	1	5x5	España	Disponibile Available	332,76
0494	RB060519	1219x1028	Readyblock - Kit en aluminio Kit in aluminum	Aluminio Aluminum	Aluminio mate Satin aluminum	1	6x5	España	Disponibile Available	377,94
0495	RB070519	1410x1028	Readyblock - Kit en aluminio Kit in aluminum	Aluminio Aluminum	Aluminio mate Satin aluminum	1	7x5	España	Disponibile Available	407,13
0496	RB080519	1601x1028	Readyblock - Kit en aluminio Kit in aluminum	Aluminio Aluminum	Aluminio mate Satin aluminum	1	8x5	España	Disponibile Available	416,07
0497	RB090519	1792x1028	Readyblock - Kit en aluminio Kit in aluminum	Aluminio Aluminum	Aluminio mate Satin aluminum	1	9x5	España	Disponibile Available	444,93
0498	RB100519	1983x1028	Readyblock - Kit en aluminio Kit in aluminum	Aluminio Aluminum	Aluminio mate Satin aluminum	1	10X5	España	Disponibile Available	454,28
0499	RB110519	2174x1028	Readyblock - Kit en aluminio Kit in aluminum	Aluminio Aluminum	Aluminio mate Satin aluminum	1	11X5	España	Disponibile Available	683,88
0500	RB120519	2365x1028	Readyblock - Kit en aluminio Kit in aluminum	Aluminio Aluminum	Aluminio mate Satin aluminum	1	12X5	España	Disponibile Available	712,58
0501	RB130519	2556x1028	Readyblock - Kit en aluminio Kit in aluminum	Aluminio Aluminum	Aluminio mate Satin aluminum	1	13X5	España	Disponibile Available	724,63
0502	RB140519	2747x1028	Readyblock - Kit en aluminio Kit in aluminum	Aluminio Aluminum	Aluminio mate Satin aluminum	1	14X5	España	Disponibile Available	750,79
0503	RB150519	2938x1028	Readyblock - Kit en aluminio Kit in aluminum	Aluminio Aluminum	Aluminio mate Satin aluminum	1	15X5	España	Disponibile Available	759,81
0504	RB010419	264x837	Readyblock - Kit en aluminio Kit in aluminum	Aluminio Aluminum	Aluminio mate Satin aluminum	1	1x4	España	Disponibile Available	157,11
0505	RB020419	455x837	Readyblock - Kit en aluminio Kit in aluminum	Aluminio Aluminum	Aluminio mate Satin aluminum	1	2x4	España	Disponibile Available	164,31
0506	RB030419	646x837	Readyblock - Kit en aluminio Kit in aluminum	Aluminio Aluminum	Aluminio mate Satin aluminum	1	3x4	España	Disponibile Available	191,63
0507	RB040419	837x837	Readyblock - Kit en aluminio Kit in aluminum	Aluminio Aluminum	Aluminio mate Satin aluminum	1	4x4	España	Disponibile Available	287,49
0508	RB050419	1028x837	Readyblock - Kit en aluminio Kit in aluminum	Aluminio Aluminum	Aluminio mate Satin aluminum	1	5x4	España	Disponibile Available	314,88
0509	RB060419	1219x837	Readyblock - Kit en aluminio Kit in aluminum	Aluminio Aluminum	Aluminio mate Satin aluminum	1	6x4	España	Disponibile Available	333,99
0510	RB070419	1410x837	Readyblock - Kit en aluminio Kit in aluminum	Aluminio Aluminum	Aluminio mate Satin aluminum	1	7x4	España	Disponibile Available	361,37
0511	RB080419	1601x837	Readyblock - Kit en aluminio Kit in aluminum	Aluminio Aluminum	Aluminio mate Satin aluminum	1	8x4	España	Disponibile Available	368,51
0512	RB090419	1792x837	Readyblock - Kit en aluminio Kit in aluminum	Aluminio Aluminum	Aluminio mate Satin aluminum	1	9x4	España	Disponibile Available	395,90
0513	RB100419	1983x837	Readyblock - Kit en aluminio Kit in aluminum	Aluminio Aluminum	Aluminio mate Satin aluminum	1	10x4	España	Disponibile Available	403,11
0514	RB110419	2174x837	Readyblock - Kit en aluminio Kit in aluminum	Aluminio Aluminum	Aluminio mate Satin aluminum	1	11x4	España	Disponibile Available	479,70
0515	RB120419	2365x837	Readyblock - Kit en aluminio Kit in aluminum	Aluminio Aluminum	Aluminio mate Satin aluminum	1	12x4	España	Disponibile Available	631,97
0516	RB130419	2556x837	Readyblock - Kit en aluminio Kit in aluminum	Aluminio Aluminum	Aluminio mate Satin aluminum	1	13x4	España	Disponibile Available	659,28
0517	RB140419	2747x837	Readyblock - Kit en aluminio Kit in aluminum	Aluminio Aluminum	Aluminio mate Satin aluminum	1	14x4	España	Disponibile Available	666,50
0518	RB150419	2938x837	Readyblock - Kit en aluminio Kit in aluminum	Aluminio Aluminum	Aluminio mate Satin aluminum	1	15x4	España	Disponibile Available	693,88

X1	Código Code	Dimensiones Dimensions MM X MM	Descripción Description	Color Colour	Acabado Finishing	Kit x caja Kit per box Solo sistema, no vidrio System only, no glass block	N° bloques de vidrio N° glass blocks	Origen material Material origin	Plazo de entrega Delivery term	Precio PVP por pared cortada a medida, sin cristal PVP price per wall cut to size, excluding glass + IVA / TVA
0519	RB010319	264x646	Readyblock - Kit en aluminio Kit in aluminum	Aluminio Aluminum	Aluminio mate Satin aluminum	1	1x3	España	Disponibile Available	146,37
0520	RB020319	455x646	Readyblock - Kit en aluminio Kit in aluminum	Aluminio Aluminum	Aluminio mate Satin aluminum	1	2x3	España	Disponibile Available	151,70
0521	RB030319	646x646	Readyblock - Kit en aluminio Kit in aluminum	Aluminio Aluminum	Aluminio mate Satin aluminum	1	3x3	España	Disponibile Available	177,28
0522	RB040319	837x646	Readyblock - Kit en aluminio Kit in aluminum	Aluminio Aluminum	Aluminio mate Satin aluminum	1	4x3	España	Disponibile Available	182,04
0523	RB050319	1028x646	Readyblock - Kit en aluminio Kit in aluminum	Aluminio Aluminum	Aluminio mate Satin aluminum	1	5x3	España	Disponibile Available	276,59
0524	RB060319	1219x646	Readyblock - Kit en aluminio Kit in aluminum	Aluminio Aluminum	Aluminio mate Satin aluminum	1	6x3	España	Disponibile Available	310,21
0525	RB070319	1410x646	Readyblock - Kit en aluminio Kit in aluminum	Aluminio Aluminum	Aluminio mate Satin aluminum	1	7x3	España	Disponibile Available	315,62
0526	RB080319	1601x646	Readyblock - Kit en aluminio Kit in aluminum	Aluminio Aluminum	Aluminio mate Satin aluminum	1	8x3	España	Disponibile Available	320,95
0527	RB090319	1792x646	Readyblock - Kit en aluminio Kit in aluminum	Aluminio Aluminum	Aluminio mate Satin aluminum	1	9x3	España	Disponibile Available	346,53
0528	RB100319	1983x646	Readyblock - Kit en aluminio Kit in aluminum	Aluminio Aluminum	Aluminio mate Satin aluminum	1	10x3	España	Disponibile Available	351,94
0529	RB110319	2174x646	Readyblock - Kit en aluminio Kit in aluminum	Aluminio Aluminum	Aluminio mate Satin aluminum	1	11x3	España	Disponibile Available	368,84
0530	RB120319	2365x646	Readyblock - Kit en aluminio Kit in aluminum	Aluminio Aluminum	Aluminio mate Satin aluminum	1	12x3	España	Disponibile Available	402,62
0531	RB130319	2556x646	Readyblock - Kit en aluminio Kit in aluminum	Aluminio Aluminum	Aluminio mate Satin aluminum	1	13x3	España	Disponibile Available	576,87
0532	RB140319	2747x646	Readyblock - Kit en aluminio Kit in aluminum	Aluminio Aluminum	Aluminio mate Satin aluminum	1	14x3	España	Disponibile Available	602,45
0533	RB150319	2938x646	Readyblock - Kit en aluminio Kit in aluminum	Aluminio Aluminum	Aluminio mate Satin aluminum	1	15x3	España	Disponibile Available	607,87
0534	RB010219	264x455	Readyblock - Kit en aluminio Kit in aluminum	Aluminio Aluminum	Aluminio mate Satin aluminum	1	1x2	España	Disponibile Available	135,55
0535	RB020219	455x455	Readyblock - Kit en aluminio Kit in aluminum	Aluminio Aluminum	Aluminio mate Satin aluminum	1	2x2	España	Disponibile Available	139,40
0536	RB030219	646x455	Readyblock - Kit en aluminio Kit in aluminum	Aluminio Aluminum	Aluminio mate Satin aluminum	1	3x2	España	Disponibile Available	142,68
0537	RB040219	837x455	Readyblock - Kit en aluminio Kit in aluminum	Aluminio Aluminum	Aluminio mate Satin aluminum	1	4x2	España	Disponibile Available	146,29
0538	RB050219	1028x455	Readyblock - Kit en aluminio Kit in aluminum	Aluminio Aluminum	Aluminio mate Satin aluminum	1	5x2	España	Disponibile Available	170,07
0539	5B060219	1219x455	Readyblock - Kit en aluminio Kit in aluminum	Aluminio Aluminum	Aluminio mate Satin aluminum	1	6x2	España	Disponibile Available	266,25
0540	RB070219	1410x455	Readyblock - Kit en aluminio Kit in aluminum	Aluminio Aluminum	Aluminio mate Satin aluminum	1	7x2	España	Disponibile Available	269,78
0541	RB080219	1601x455	Readyblock - Kit en aluminio Kit in aluminum	Aluminio Aluminum	Aluminio mate Satin aluminum	1	8x2	España	Disponibile Available	273,39
0542	RB090219	1792x455	Readyblock - Kit en aluminio Kit in aluminum	Aluminio Aluminum	Aluminio mate Satin aluminum	1	9x2	España	Disponibile Available	296,84
0543	RB100219	1983x455	Readyblock - Kit en aluminio Kit in aluminum	Aluminio Aluminum	Aluminio mate Satin aluminum	1	10x2	España	Disponibile Available	302,42
0544	RB110219	2174x455	Readyblock - Kit en aluminio Kit in aluminum	Aluminio Aluminum	Aluminio mate Satin aluminum	1	11x2	España	Disponibile Available	310,16
0545	RB120219	2365x455	Readyblock - Kit en aluminio Kit in aluminum	Aluminio Aluminum	Aluminio mate Satin aluminum	1	12x2	España	Disponibile Available	313,73

X1	Código Code	Dimensiones	Descripción Description	Color Colour	Acabado Finishing	Kit x caja	N° bloques de vidrio N° glass blocks	Origen material Material origin	Plazo de entrega Delivery term	Precio PVP por pared cortada a medida, sin cristal PVP price per wall cut to size, excluding glass + IVA / TVA
		Dimensions MM X MM				Kit per box				
0546	RB130219	2556x455	Readyblock - Kit en aluminio Kit in aluminum	Aluminio Aluminum	Aluminio mate Satin aluminum	1	13x2	España	Disponibile Available	337,51
0547	RB140219	2747x455	Readyblock - Kit en aluminio Kit in aluminum	Aluminio Aluminum	Aluminio mate Satin aluminum	1	14x2	España	Disponibile Available	518,24
0548	RB150219	2938x455	Readyblock - Kit en aluminio Kit in aluminum	Aluminio Aluminum	Aluminio mate Satin aluminum	1	15x2	España	Disponibile Available	521,77
0549	RB010119	264x264	Readyblock - Kit en aluminio Kit in aluminum	Aluminio Aluminum	Aluminio mate Satin aluminum	1	1X1	España	Disponibile Available	125,44
0550	RB020119	455x264	Readyblock - Kit en aluminio Kit in aluminum	Aluminio Aluminum	Aluminio mate Satin aluminum	1	2X1	España	Disponibile Available	127,10
0551	RB030119	646x264	Readyblock - Kit en aluminio Kit in aluminum	Aluminio Aluminum	Aluminio mate Satin aluminum	1	3X1	España	Disponibile Available	128,33
0552	RB040119	837x264	Readyblock - Kit en aluminio Kit in aluminum	Aluminio Aluminum	Aluminio mate Satin aluminum	1	4X1	España	Disponibile Available	130,13
0553	RB050119	1028x264	Readyblock - Kit en aluminio Kit in aluminum	Aluminio Aluminum	Aluminio mate Satin aluminum	1	5X1	España	Disponibile Available	131,94
0554	RB060119	1219x264	Readyblock - Kit en aluminio Kit in aluminum	Aluminio Aluminum	Aluminio mate Satin aluminum	1	6X1	España	Disponibile Available	133,66
0555	RB070119	1410x264	Readyblock - Kit en aluminio Kit in aluminum	Aluminio Aluminum	Aluminio mate Satin aluminum	1	7X1	España	Disponibile Available	224,11
0556	RB080119	1601x264	Readyblock - Kit en aluminio Kit in aluminum	Aluminio Aluminum	Aluminio mate Satin aluminum	1	8X1	España	Disponibile Available	225,91
0557	RB090119	1792x264	Readyblock - Kit en aluminio Kit in aluminum	Aluminio Aluminum	Aluminio mate Satin aluminum	1	9X1	España	Disponibile Available	247,80
0558	RB100119	1983x264	Readyblock - Kit en aluminio Kit in aluminum	Aluminio Aluminum	Aluminio mate Satin aluminum	1	10X1	España	Disponibile Available	249,69
0559	RB110119	2174x264	Readyblock - Kit en aluminio Kit in aluminum	Aluminio Aluminum	Aluminio mate Satin aluminum	1	11X1	España	Disponibile Available	251,41
0560	RB120119	2365x264	Readyblock - Kit en aluminio Kit in aluminum	Aluminio Aluminum	Aluminio mate Satin aluminum	1	12X1	España	Disponibile Available	253,30
0561	RB130119	2556x264	Readyblock - Kit en aluminio Kit in aluminum	Aluminio Aluminum	Aluminio mate Satin aluminum	1	13X1	España	Disponibile Available	255,02
0562	RB140119	2747x264	Readyblock - Kit en aluminio Kit in aluminum	Aluminio Aluminum	Aluminio mate Satin aluminum	1	14X1	España	Disponibile Available	256,82
0563	RB150119	2938x264	Readyblock - Kit en aluminio Kit in aluminum	Aluminio Aluminum	Aluminio mate Satin aluminum	1	15X1	España	Disponibile Available	285,40

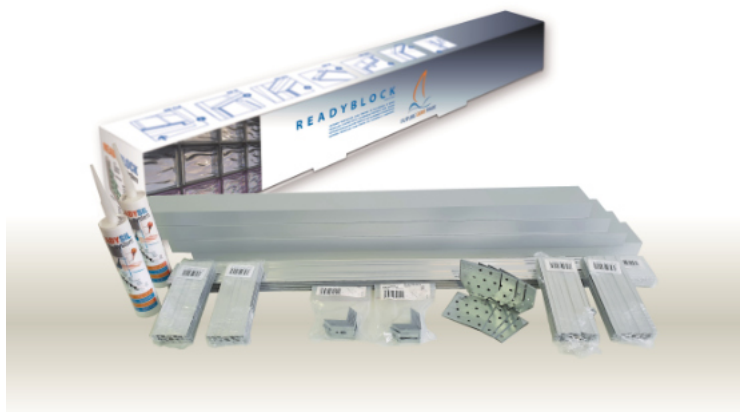

Y METAL SYSTEM

Y1 SISTEMA MODULAR EN ALUMINIO PARA PAREDES DE GRANDES Y PEQUEÑAS DIMENSIONES CON BLOQUE DE VIDRIO MODULAR ALUMINUM SYSTEM FOR LARGE AND SMALL DIMENSION WALLS WITH GLASS BLOCK

	Código Code	Dimensiones Dimensions MM X MM	Descripción Description	Color Colour	Acabado Finishing	Pzas. x caja Pcs. x box	Kgs. x pza. Kg. x pc. Kgs. x caja Kg. x box	Origen material Material origin	Plazo de entrega Delivery term	Euro pza. x caja completa Euro pc. x full box + IVA / TVA
0564	CH-80/19-600	6000	Perfil Horiz. Horizontal Profile	Aluminio Aluminum	Aluminio mate Satin aluminum	5	4,95 24,75	España	Disponibile Available	165,00
0565	CH-80/19-300	3000	Perfil Horiz. Horizontal Profile	Aluminio Aluminum	Aluminio mate Satin aluminum	5	2,47 12,35	España	Disponibile Available	83,00
0566	CH-80/19-200	2000	Perfil Horiz. Horizontal Profile	Aluminio Aluminum	Aluminio mate Satin aluminum	5	1,65 8,25	España	Disponibile Available	57,00
0567	CH_80/19-100	1000	Perfil Horiz. Horizontal Profile	Aluminio Aluminum	Aluminio mate Satin aluminum	5	0,825 4,12	España	Disponibile Available	31,00
0568	PU-80/600C	6000	Perfil Perimetral Perimetral Profile	Aluminio Aluminum	Aluminio mate Satin aluminum	4	6,12 24,50	España	Disponibile Available	205,00
0569	PU-80/300C	3000	Perfil Perimetral Perimetral Profile	Aluminio Aluminum	Aluminio mate Satin aluminum	4	3,06 12,24	España	Disponibile Available	102,00
0570	PU-80/200C	2000	Perfil Perimetral Perimetral Profile	Aluminio Aluminum	Aluminio mate Satin aluminum	4	2,04 8,15	España	Disponibile Available	82,00
0571	PU-80/100C	1000	Perfil Perimetral Perimetral Profile	Aluminio Aluminum	Aluminio mate Satin aluminum	4	0,51 2,04	España	Disponibile Available	43,00
0572	HH-80/19	190/H	Separación Vert. Vertical Separation	Aluminio Aluminum	Aluminio mate Satin aluminum	10	0,14 1,40	España	Disponibile Available	9,20
0573	HH-80/24	240/H	Separación Vert. Vertical Separation	Aluminio Aluminum	Aluminio mate Satin aluminum	10	0,20 2,00	España	Disponibile Available	11,30
0574	S-42		Adaptador Adapter			10		España	Disponibile Available	1,45
0575	A-80		Fijación Perimetral Perimeter Fixing					España	Disponibile Available	1,45

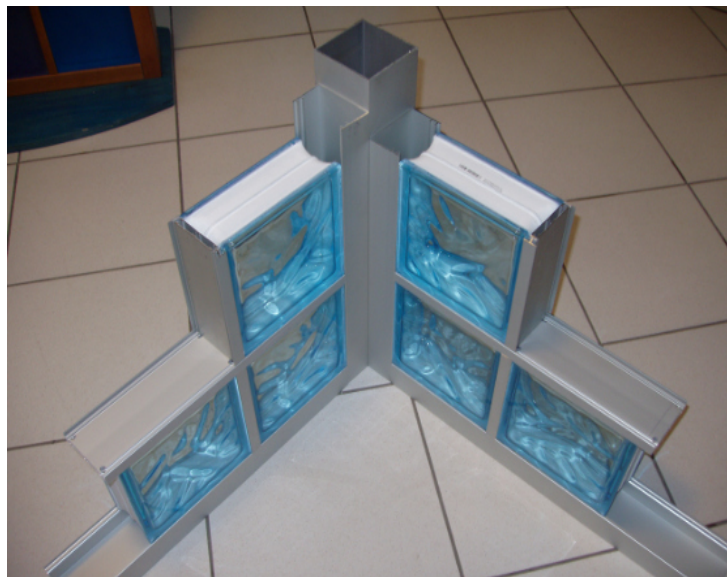

Z BINARIO SYSTEM

Z1 SISTEMA MODULAR EN PVC BLANCO PARA PAREDES PLANAS Y CURVAS CON BLOQUE DE VIDRIO MODULAR SYSTEM IN WHITE PVC FOR FLAT AND CURVED WALLS WITH GLASS BLOCK

	Código Code	Dimensiones Dimensions MM X MM	Descripción Description	Color Colour	Acabado Finishing	Pzas. x caja Pcs. x box	Kgs. x pza. Kg. x pc. Kgs. x caja Kg. x box	Origen material Material origin	Plazo de entrega Delivery term	Euro pza. x caja completa Euro pc. x full box + IVA / TVA
0576	PUC-600 B/W	6000	Perfil Perimetral Perimetral Profile	PVC - Blanco White	PVC - Blanco White	2	3,42 6,84	Italia	Disponibile Available	106,00
0577	PUC-300 B/W	3000	Perfil Perimetral Perimetral Profile	PVC - Blanco White	PVC - Blanco White	2	1,71 3,42	Italia	Disponibile Available	53,00
0578	PUC-200 B/W	2000	Perfil Perimetral Perimetral Profile	PVC - Blanco White	PVC - Blanco White	2	1,14 2,28	Italia	Disponibile Available	37,00
0579	PUC-100 B/W	1000	Perfil Perimetral Perimetral Profile	PVC - Blanco White	PVC - Blanco White	4	0,57 2,28	Italia	Disponibile Available	19,50
0580	C-600 B/W	6000	Perfil Horiz. Horizontal Profile	PVC - Blanco White	PVC - Blanco White	2	1,08 2,16	Italia	Disponibile Available	60,00
0581	C-300 B/W	3000	Perfil Horiz. Horizontal Profile	PVC - Blanco White	PVC - Blanco White	2	0,54 1,08	Italia	Disponibile Available	30,00
0582	C-200 B/W	2000	Perfil Horiz. Horizontal Profile	PVC - Blanco White	PVC - Blanco White	2	0,36 0,72	Italia	Disponibile Available	24,00
0583	C-100 B/W	1000	Perfil Horiz. Horizontal Profile	PVC - Blanco White	PVC - Blanco White	4	0,18 0,72	Italia	Disponibile Available	14,00
0584	H-24 B/W	240 /H	Separación Vert. Vertical Separation	PVC - Blanco White	PVC - Blanco White	100	0,048 4,80	Italia	Disponibile Available	4,00
0585	H-19 B/W	190/H	Separación Vert. Vertical Separation	PVC - Blanco White	PVC - Blanco White	100	0,038 3,80	Italia	Disponibile Available	3,20
0586	HC-24 B/W	240/H	Separ. Vert. Curva Vert. Separ. Curved	PVC - Blanco White	PVC - Blanco White	100	0,048 4,80	Italia	Disponibile Available	4,90
0587	HC-19 B/W	190/H	Separ. Vert. Curva Vert. Separ. Curved	PVC - Blanco White	PVC - Blanco White	100	0,038 3,80	Italia	Disponibile Available	3,90
0588	CAV-25		Refuerzo Perimetral Perimetral Reinforc.			50	0,064 3,20	Italia	Disponibile Available	2,30

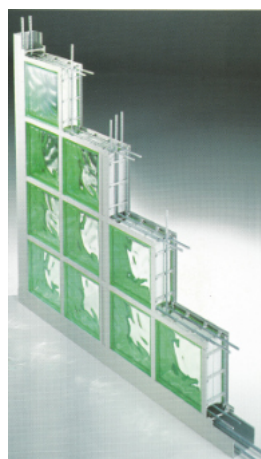
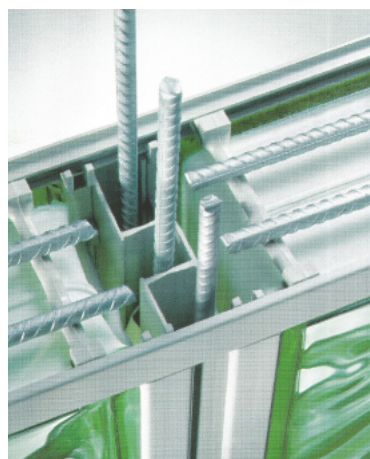

Crea tu pared de ladrillos de vidrio con el sistema BINARIO de PVC, elegante, rápido y fácil de montar.

BINARIO
MADE IN ITALY
SISTEMA MODULAR PARA BLOQUE DE VIDRIO
ESTRUCTURA EN PVC

¿QUÉ SE NECESITA? | ¿CÓMO HACER? | ¡EL RESULTADO!



AA CRYSTAL FULL BRICK: LADRILLO DE VIDRIO MACIZO | SOLID GLASS BRICK

AA1 MM 100X200X50 - 100X100X50 NEUTRO Y SATINADO | CLEAR AND SATIN

	Código Code	Dimensiones Dimensions MM X MM	Descripción Description	Color Colour	Acabado Finishing	Pzas. x caja Pcs. x box	Kgs. x pza. Kg. x pc.	Origen material Material origin	Plazo de entrega Delivery term	Euro pza. x caja completa Euro pc. x full box + IVA / TVA
0589	CC100FB	100x200x50	Crystal Neutro Ladrillo Entero	Transparente Clear	Liso Smooth	5 300 60	2,50 12,00 720	Import	Disponibile Available	29,60
0590	CC105FB	100x100x50	Crystal Neutro Medio Ladrillo	Transparente Clear	Liso Smooth	10 600 60	1,50 15,00 900	Import	Disponibile Available	23,50
0591	CC110FB	100x200x50	Crystal Satinado Ladrillo Entero	Neutro mateado matte	Liso mateado Matte smooth	5 300 60	2,50 12,00 720	Made in Future Euro Trade	2 semanas 2 weeks	39,90
0592	CC115FB	100x100x50	Crystal Satinado Medio Ladrillo	Neutro mateado matte	Liso mateado Matte smooth	10 600 60	1,50 15,00 900	Made in Future Euro Trade	2 semanas 2 weeks	26,90
0593	ARS-SB2	290 ML	Silicon Color Cristalino	Transparente Clear	Liso Smooth	12 Pzas. x caja Pcs. x box	0,300 3,60	Europa	Disponibile Available	24,00

AA2 MM 100X200X50 COLOREADO EN MASA | MASS COLOURED

0594	CC100-DG	100x200x50	Crystal Neutro Verde Oscuro / Dark Green	Verde Oscuro Dark Green	Liso Smooth	5 300 60	2,50 12,00 720	Import	Bajo pedido On request	62,50
0595	CC100-LG	100x200x50	Crystal Neutro Verde Claro / Light Green	Verde Claro Light Green	Liso Smooth	5 300 60	2,50 12,00 720	Import	Bajo pedido On request	62,50
0596	CC100-BC	100x200x50	Crystal Neutro Blu Cobalto / Dark Blue	Blu Cobalto Dark Blue	Liso Smooth	5 300 60	2,50 12,00 720	Import	Bajo pedido On request	62,50
0597	CC100-LB	100x200x50	Crystal Neutro Azul / Light Blue	Azul Light Blue	Liso Smooth	5 300 60	2,50 12,00 720	Import	Bajo pedido On request	62,50
0598	CC100-AG	100x200x50	Crystal Neutro Aguamarina / Aquamarine	Aguamarina Aquamarine	Liso Smooth	5 300 60	2,50 12,00 720	Import	Bajo pedido On request	62,50
0599	CC100-YL	100x200x50	Crystal Neutro Amarillo / Yellow	Amarillo Yellow	Liso Smooth	5 300 60	2,50 12,00 720	Import	Bajo pedido On request	62,50
0600	CC110-BR	100x200x50	Crystal Neutro Bronce / Brown	Bronce Brown	Liso Smooth	5 300 60	2,50 12,00 720	Import	Bajo pedido On request	62,50
0601	CC100-GD	100x200x50	Crystal Neutro Oro / Gold	Oro Gold	Liso Smooth	5 300 60	2,50 12,00 720	Import	Bajo pedido On request	62,50
0602	CC110-RJ	100x200x50	Crystal Neutro Rojo / Red	Rojo Red	Liso Smooth	5 300 60	2,50 12,00 720	Import	Bajo pedido On request	62,50
0603	ARS-SB2	290 ML	Silicon Color Cristalino	Transparente Clear	Liso Smooth	12 Pzas. x caja Pcs. x box	0,300 3,60	Europa	Disponibile Available	24,00

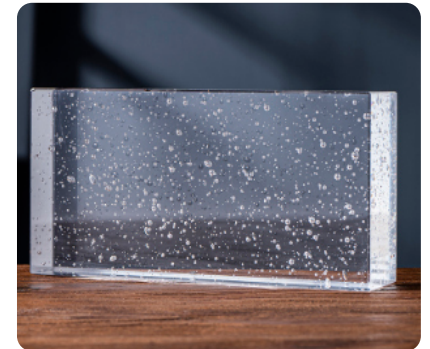
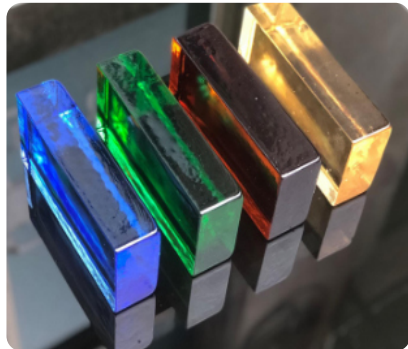

BB GLASS BLOCKS ALABASTER

BB1 REALIZACIÓN MEDIANTE LA APLICACIÓN DE UNA LOSA DE ALABASTRO PEGADA CON SILICONA TRANSPARENTS DESDE UN LADO DE UN BLOQUE DE VIDRIO
 MADE BY APPLYING AN ALABASTER SLAB GLUED WITH TRANSPARENT SILICONE FROM ONE SIDE TO A GLASS BLOCK

	Código Code	Dimensiones Dimensions MM X MM	Descripción Description	Color Colour	Acabado Finishing	Pzas. x caja Pcs. x box Pzas. x palet Pcs x pallet Caja x palet Box x pallet	Kgs. x pza. Kg. x pc. Kgs. x caja Kg. x box Kgs. x palet Kg. x pallet	Origen material Material origin	Plazo de entrega Delivery term	Euro pza. x caja completa Euro pc. x full box + IVA / TVA
0604	AT006AW	190x190x90	Groga Wave	Transparente Clear	Ondulado-Liso Wavy-Clear	5 225 45	2,85 14,25 642	Europa	Bajo pedido On request	65,00
0605	AT007AC	190x190x90	Groga Clear	Transparente Clear	Ondulado-Liso Wavy-Clear	5 225 45	2,85 14,25 642	Europa	Bajo pedido On request	65,00
0606	AT008AW	190x190x90	La Zaida Wave	Transparente Clear	Ondulado-Liso Wavy-Clear	5 225 45	2,85 14,25 642	Europa	Bajo pedido On request	70,00
0607	AT009AC	190x190x90	La Zaida Clear	Transparente Clear	Ondulado-Liso Wavy-Clear	5 225 45	2,85 14,25 642	Europa	Bajo pedido On request	70,00
0608	AT010AW	190x190x90	Sotenal Wave	Transparente Clear	Ondulado-Liso Wavy-Clear	5 225 45	2,85 14,25 642	Europa	Bajo pedido On request	75,00
0609	AT011AC	190x190x90	Sotenal Clear	Transparente Clear	Ondulado-Liso Wavy-Clear	5 225 45	2,85 14,25 642	Europa	Bajo pedido On request	75,00





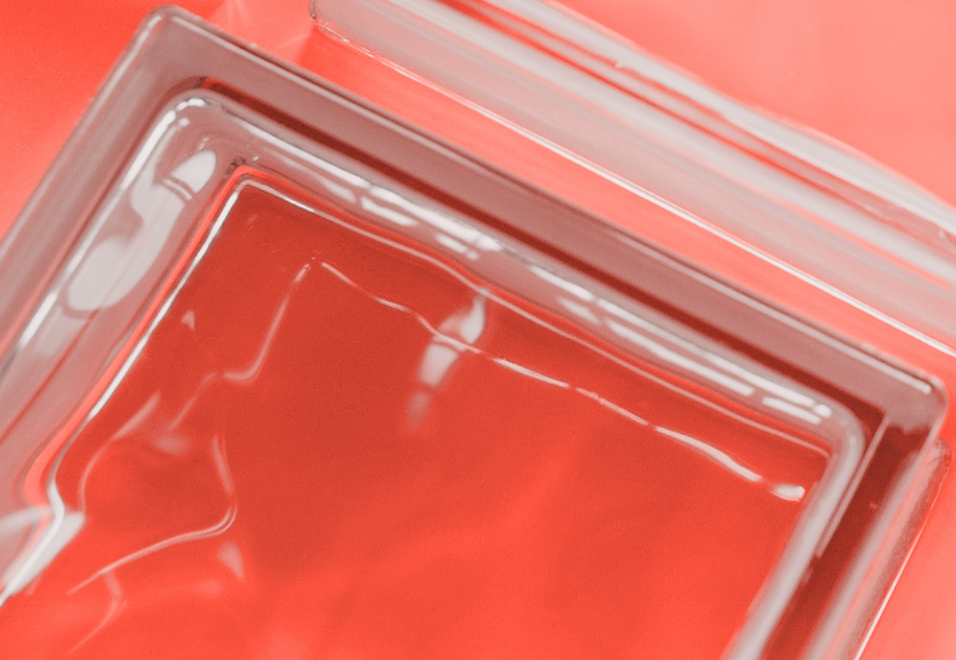

Pedidos

El envío de pedidos se realizará exclusivamente por fax o correo electrónico a Future Euro Trade, S.L.

No se aceptarán pedidos telefónicos. Una vez recibido el pedido, se procederá a la emisión de una confirmación del mismo y se cursará una solicitud de confirmación/aceptación firmada por parte del cliente. No se aceptarán pedidos sin previa emisión de nuestra confirmación de pedido, que tendrá que sernos devuelta por correo electrónico o fax confirmada, firmada y sellada.

Los plazos de entrega serán informativos y sin ninguna responsabilidad por nuestra parte. La entrega del material será EXW, desde nuestros almacenes ubicados en 12200 Onda (Castellón).

Nuestra responsabilidad alcanzará hasta el momento de la retirada de los materiales por parte del transitario/transportador/cliente, por lo que las reclamaciones que pudieran realizarse por eventuales déficits o roturas tendrán que ser comunicadas exclusivamente al transitario/transportador/cliente.

No se aceptarán anulaciones parciales o totales del pedido transcurridas 48 horas desde la recepción de nuestra confirmación pedido firmada y aceptada, ni tampoco podrán aceptarse restituciones parciales o totales de los materiales entregados.

Tonos

Para conseguir una estética atractiva es aconsejable, antes de su colocación, mezclar cuidadosamente piezas de diferentes cajas.

Existen productos que presentan cierto grado de destonificación por su propio diseño y/o proceso productivo. Los colores presentados en esta tarifa son orientativos y pueden variar de los colores reales.

Future Euro Trade se reserva el derecho de modificar, en cualquier momento, formatos, colores y series de su colección, sin que constituya motivo alguno de reclamación por parte de sus clientes. También se reserva la potestad de anular la producción de determinados artículos representados en esta tarifa. Los colores y tonos del material suministrado pueden diferir ligeramente con respecto a las muestras y catálogo.

Packing

Se debe consultar siempre el packing para realizar los pedidos acorde a las unidades/caja /palet determinadas en esta tarifa.

Dicho packing podrá sufrir variaciones por requerimientos de logística y/o producción.

El peso expresado en esta tarifa corresponde al peso neto. A efectos de transporte, deberá incrementarse un 3% en concepto de embalaje. Las medidas están expresadas en mm.

Reclamaciones y notificaciones

No se admitirán reclamaciones una vez colocado el material. Future Euro Trade no se responsabilizará de posibles reclamaciones en las que no se hayan cumplido adecuadamente las normas de colocación o que no sean de primera calidad.

Será responsabilidad del cliente revisar los productos en el momento de la entrega para asegurarse de que se encuentran en condiciones satisfactorias, sin ningún daño obvio, y entregados en las cantidades descritas en el pedido. En caso contrario, deberá notificarlo dentro de los 2 días posteriores a la recepción del pedido.

Puede haber algunas diferencias en las tonalidades en comparación con las del catálogo donde las tonalidades son solo indicativas.

Pagos

Los precios de Future Euro Trade se detallan y especifican en las ofertas/confirmaciones de pedido.

A menos que se acuerde lo contrario por escrito, los precios de los productos no incluyen impuestos. Los términos y condiciones de pago se detallarán en la confirmación del pedido. Future Euro Trade se reserva el derecho de exigir por adelantado el pago total o parcial una vez aceptado el pedido. El retraso total o parcial del pago de las facturas vencidas por parte del cliente otorgará a Future Euro Trade el derecho de cancelar o suspender la entrega de cualquier pedido del cliente. Asimismo, el impago de cualquier factura vencida implicará el devengo de intereses vencidos desde la fecha de vencimiento de la misma hasta su pago completo.

Reserva de propiedad

La propiedad de los productos, accesorios y, en su caso, servicios asociados a ellos, será de Future Euro Trade hasta el momento del pago efectivo y completo de los mismos.

A efectos de esta cláusula, la entrega de un acuse de recibo de deuda, letra de cambio, pagaré, cheque u otros documentos similares no constituirá un pago. La reserva de dominio indicada constituye una garantía de pago del precio. Hasta el momento del pago completo de los productos, el cliente se comprometerá a protegerlos e identificarlos como propiedad de Future Euro Trade, y permitirá que Future Euro Trade y sus representantes accedan libremente a las instalaciones donde se encuentren dichos productos.

Devoluciones

Una vez que los materiales hayan sido solicitados y confirmados por nosotros, y después de las siguientes 48 horas, ya no se podrán cancelar.

Los materiales entregados que cumplan con el pedido solicitado y confirmado, y no tengan defectos de producción, no podrán ser devueltos. No se aceptarán devoluciones de material.

Orders

Orders will be sent exclusively by fax or email to Future Euro Trade, S.L.

Telephone orders will not be accepted. Once the order is received, a confirmation of the order will be issued and a confirmation / acceptance request signed by the client will be made. Orders will not be accepted without prior issuance of our order confirmation, which will have to be returned to us by email or fax confirmed, signed and stamped.

Delivery times will be informative and without any responsibility on our part. The delivery of the material will be EXW, from our warehouses located at 12200 Onda (Castellón). Our responsibility will reach until the moment of the removal of the materials by the freight forwarder / transporter / customer, so any claims that may be made due to possible deficits or breakages will have to be communicated exclusively to the freight forwarder / transporter / client. Partial or total cancellations of the order will not be accepted after 48 hours from the receipt of our signed and accepted order confirmation, nor can partial or total refunds of the materials delivered.

Tones

To achieve an attractive aesthetic, it is advisable to carefully mix pieces from different boxes before placing them.

There are products that present a certain degree of detonation due to their own design and / or production process.

The colours presented in this rate are indicative and may vary from the actual colors. Future Euro Trade reserves the right to modify, at any time, formats, colors and series of its collection without constituting any reason for complaint by its clients.

The power to cancel the production of certain items represented in this rate is also reserved. The colours and shades of the supplied material may differ slightly from the samples and catalog.

Packing

The packing must always be consulted to place orders according to the units /pieces/palet of measurement determined in this rate.

Said packing may suffer variations due to logistics and / or production requirements. The weight expressed in this rate corresponds to the net weight.

For transport purposes, it must be increased by 3% for packaging. Measurements are expressed in mm.

Claims and notifications

No claims will be accepted once the material has been placed. Future Euro Trade will not be liable for possible claims in which the placement rules have not been adequately complied with and, in no case, for materials that are not of the highest quality. It will be the responsibility of the customer to check the products at the time of delivery to ensure that they are in satisfactory condition, without any obvious damage, and delivered in the quantities described in the order.

Otherwise, you must notify it within 2 days after receiving the order. There may be some differences in the shades compared to the catalog where the shades are only indicative.

Payments

Future Euro Trade prices are detailed and specified in the offers / order confirmations.

Unless otherwise agreed in writing, product prices do not include taxes. The terms and conditions of payment will be detailed in the order confirmation.

Future Euro Trade reserves the right to demand full or partial payment in advance once the order has been accepted. The total or partial delay in the payment of overdue invoices by the client will grant Future Euro Trade the right to cancel or suspend the delivery of any client order.

Likewise, the non-payment of any overdue invoice will imply the accrual of interest due from the due date of the same until its full payment.

Reservation of ownership

The property of the products, accessories and, where appropriate, services associated with them, will be of Future Euro Trade until the moment of effective and complete payment thereof.

For the purposes of this clause, the delivery of an acknowledgment of receipt of debt, bill of exchange, promissory note, check or other similar documents will not constitute a payment. The indicated domain reservation constitutes a guarantee of payment of the price. Until the moment of full payment of the products, the client will undertake to protect and identify them as the property of Future Euro Trade, and will allow Future Euro Trade and its representatives to freely access the facilities where said products are located.

Returns

Once the materials have been requested and confirmed by us, and after the next 48 hours, they can no longer be canceled.

The materials delivered that comply with the requested and confirmed order, and do not have production defects, cannot be returned. Material returns will not be accepted.



NOTAS | NOTES





CV-20 Ctra. Vila-real - Onda Km. 6,00

Polígono Industrial Sis Quarts

12200 Onda (Castellón de la Plana) - ESPAÑA

Tel: +34 964 626795 | Fax: +34 964 626178

www.futureglassblock.com | info@fetfuture.com